

**MECCANO<sup>®</sup>**

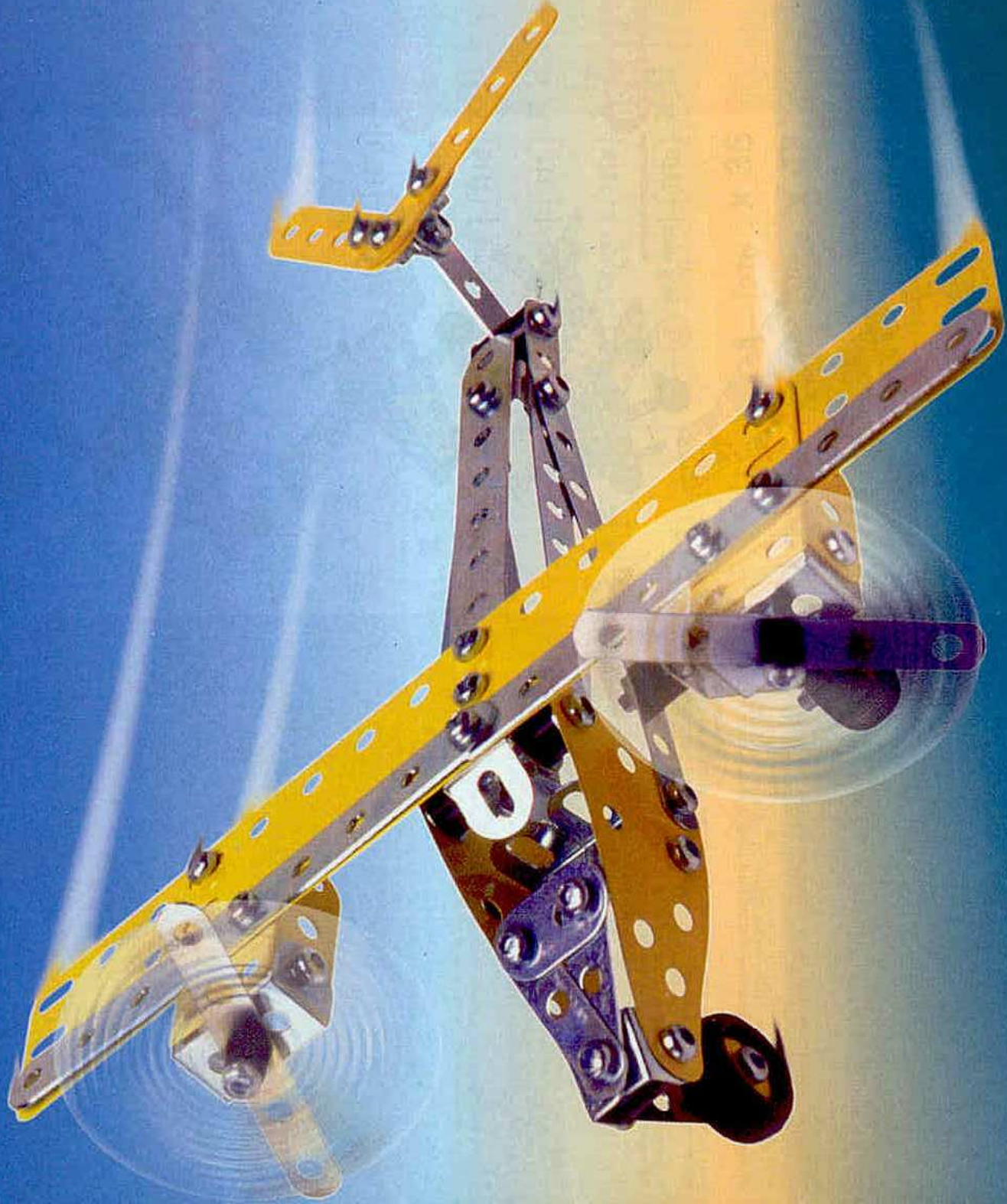

LEAFLET  
ANLEITUNG  
ISTRUZIONI  
BROSCHYR  
OHJEET  
VEJLEDNING

NOTICE  
INSTRUCCIONES  
BESCHRJVINGEN  
INSTRUCOES  
ΟΔΗΓΙΕΣ  
説明書

**3920**

P. 4 - 6

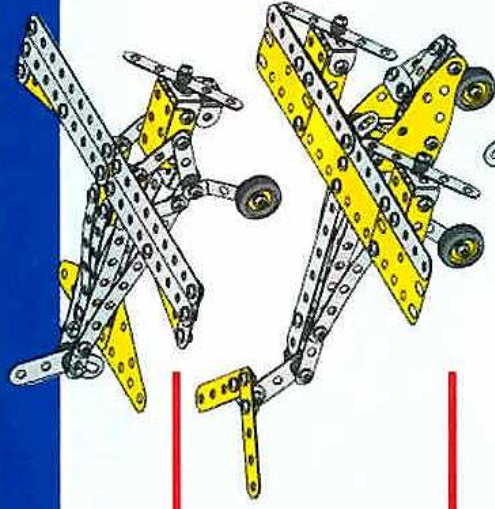

P. 7 - 10

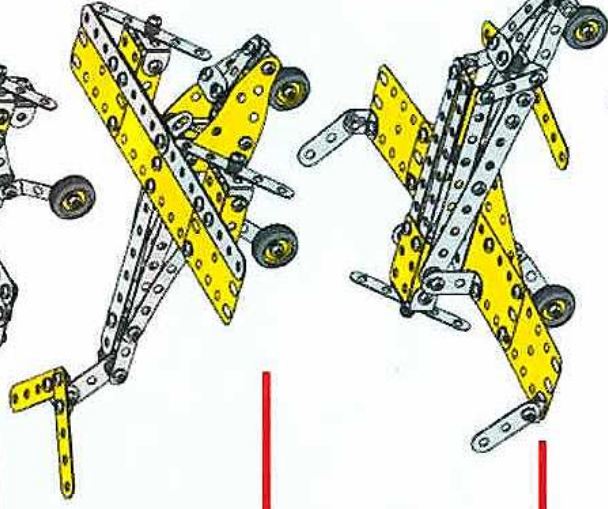

P. 11 - 14

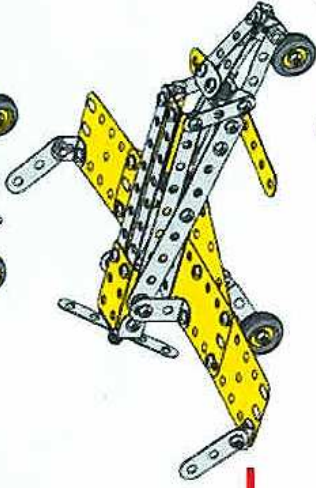

P. 15 - 17

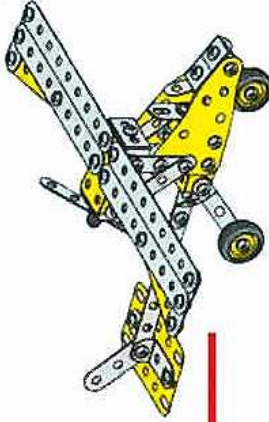

P. 18 - 20



P. 21 - 23



P. 24 - 27

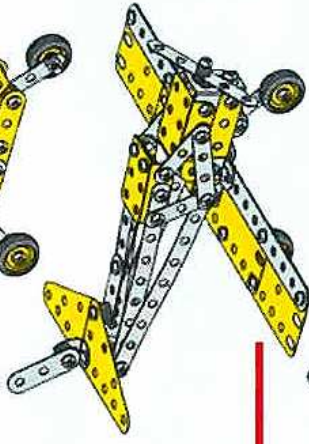

P. 28 - 31

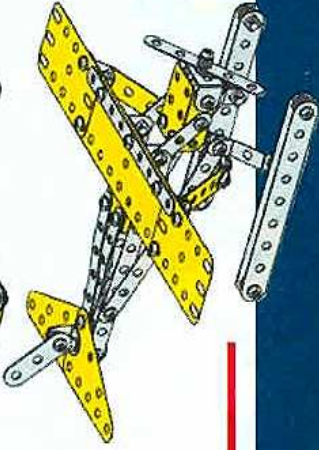

GB : Many of the models and component parts are unique and original designs which are the property of MECCANO S.A. They are protected by national legislation as industrial designs, trademarks and/or copyrights throughout many countries. For detailed information, please contact MECCANO S.A.

FR : Les nombreux modèles et pièces sont des créations originales, protégées de MECCANO S.A. et sont protégés par les législations nationales sur les dessins et modèles, marques et/ou droits d'auteurs. Pour toute information, merci de contacter MECCANO S.A.

DE : Die nombreux modèles et pièces sont des créations originales, geschützt von MECCANO S.A. und sind durch Inland-Gesetz über Zeichnungen und Modelle sowie Warenzeichen und/oder Urheberrechte geschützt. Für zusätzliche Auskünfte wenden Sie sich bitte an MECCANO S.A.

IT : Numerosi modelli e pezzi sono creazioni originali, proprietà della MECCANO S.A. e sono protetti dalle legislazioni nazionali sui disegni e modelli, marchi e/o diritti d'autore. Per qualsiasi informazione, vogliamo prendere contatto con MECCANO S.A.

ES : Muchos modelos y piezas son creaciones originales, propiedad de MECCANO S.A. y son protegidos por las legislaciones nacionales en lo que concierne a los dibujos y modelos, marcas y/o derechos de autor. Para cualquier información, sírvase ponerse en contacto con MECCANO S.A.

SE : Många modeller och delar är unika och originala föremål som är MECCANO S.A. egendom. Dessa modeller och delar är skyddade genom lagstiftning såsom inbuds- och författarrättigheter. För ytterligare upplysningar i ett flertal länder, Ytterligare upplysningar kan fås hos MECCANO S.A.

DK : Mange modeller og dele er originale fremstillinger og ejes af MECCANO S.A. Tegninger, modeller, fabriksmærker og ophavsret er lovbeskyttet i hvert land. Yderligere oplysninger kan fås hos MECCANO S.A.

NL : Veel modellen en onderdelen zijn een uniek en origineel ontwerp, hetgeen eigendom van MECCANO S.A. is. Deze modellen genieten bescherming als industrieel ontwerp, handelsmerk en/of copyright in talloze landen. Voor uitgebreide informatie, s.v.p. contact opnemen met MECCANO S.A.

PT : Muitos modelos e peças são criações originais, propriedade de MECCANO S.A. e são protegidos por as legislações nacionais em lo que concerne a los dibujos y modelos, marcas y/o derechos de autor. Para cualquier información, sírvase ponerse en contacto con MECCANO S.A.

GR : Πολλά μοντέλα και ανταλλακτικά είναι μοναδικές και πρωτότυπες δημιουργίες της MECCANO S.A. και προστατεύονται από τις εθνικές νομοθεσίες που αφορούν τα σχέδια, τα εμπορικά σήματα και/ή δικαιώματα πνευματικής ιδιοκτησίας.

JPN : 多くのモデルと部品は、ユニークでオリジナルなデザインであり、MECCANO S.A. の財産であり、多くの国で工業デザイン、商標、著作権、特許などの法律によって保護されています。

RU : Многие модели и детали являются уникальными и оригинальными разработками MECCANO S.A. и защищены законодательством многих стран в отношении патентов, товарных знаков и/или авторских прав.

CHN : 许多模型和零件是独特的原创设计，属于 MECCANO S.A. 的财产，在许多国家受到工业产权、商标和/或版权法的保护。

Indonesian text describing the originality and protection of the models and parts.

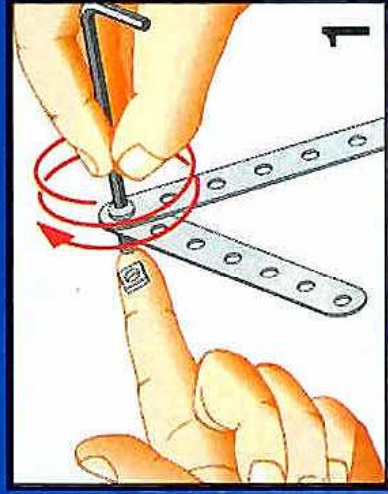

1



2

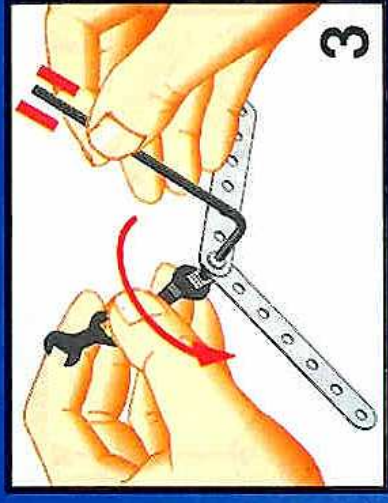

3

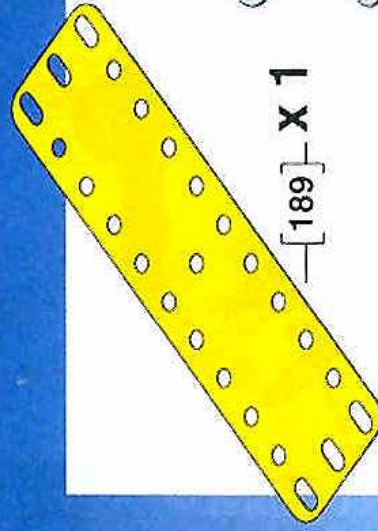

[189] X 1

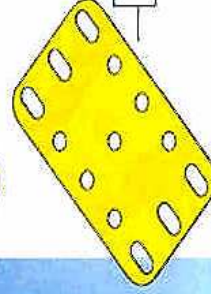

[188] X 2

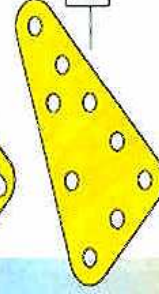

[221] X 2

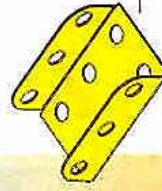

[51a] X 2

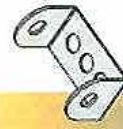

[48e] X 2



[11] X 2



[825] X 4



[812d] X 2



[23bP] X 3

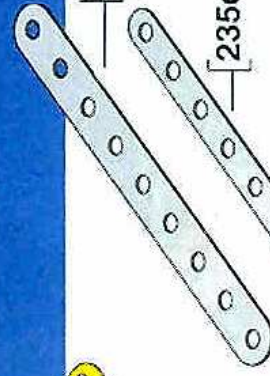

[2a] X 4

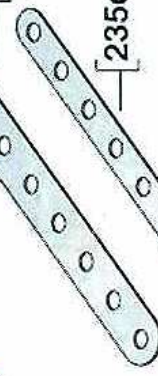

[235d] X 5



[235a] X 2



[235] X 2



[235h] X 2

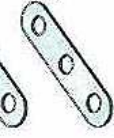

[235g] X 6

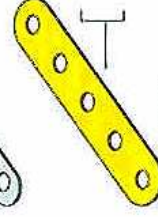

[5] X 2



[6a] X 3

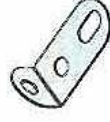

[12b] X 2



[10] X 2



[12c] X 4



[12] X 8



[38a] X 10



[38b] X 2



[7] 14,7 mm  $\frac{3}{16}$  [147d] X 5



[1] 28 mm  $1\frac{1}{16}$  [111d] X 0



[2] 19 mm  $\frac{3}{8}$  [111] X 2



[3] 12 mm  $\frac{1}{2}$  [111a] X 7



[4] 9,5 mm  $\frac{3}{8}$  [111c] X 0



[37b] X 36



[37a] X 47



[142j] X 3



[36c] X 1



[34] X 1



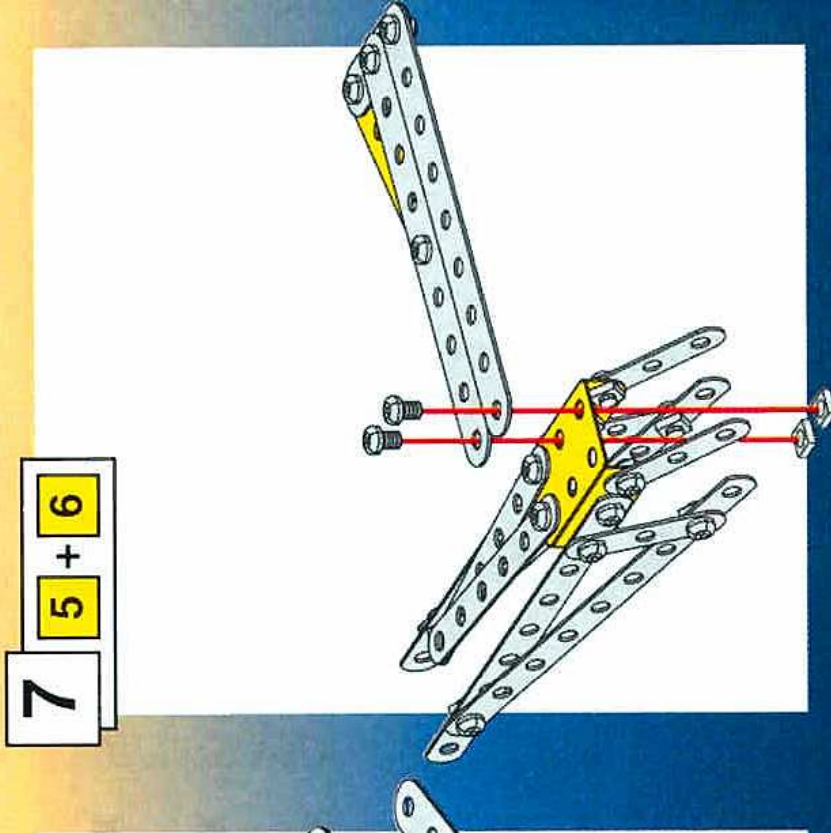
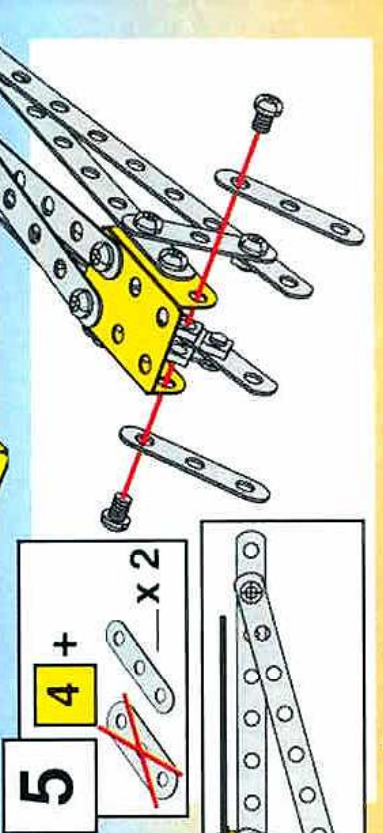
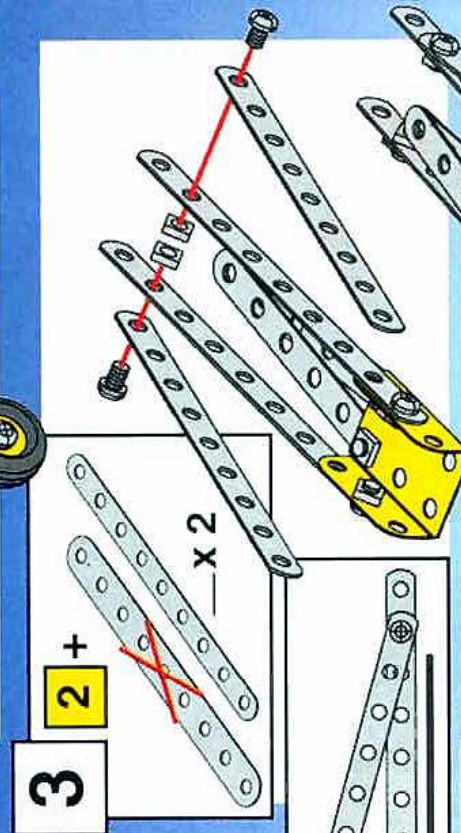
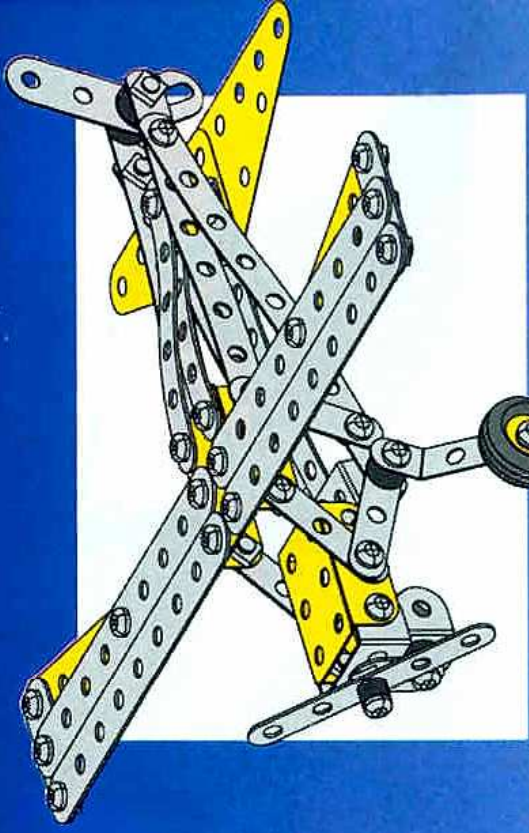
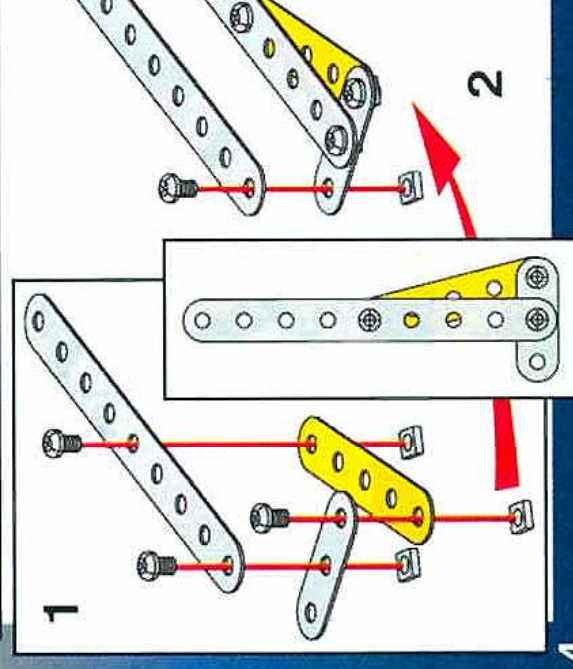
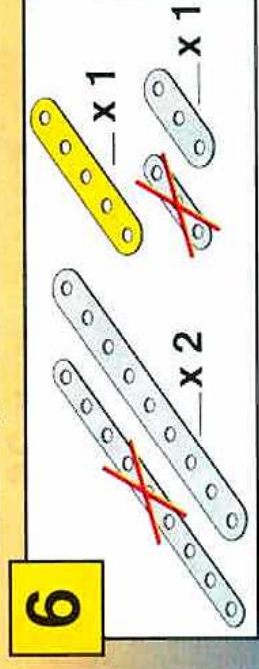
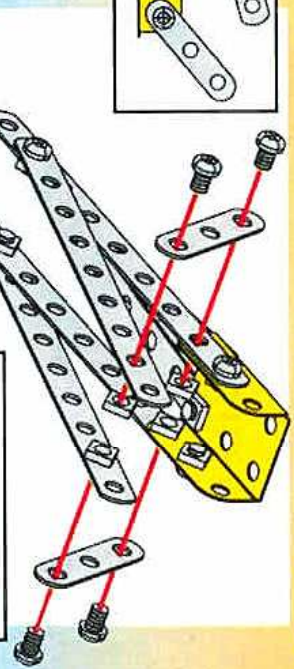
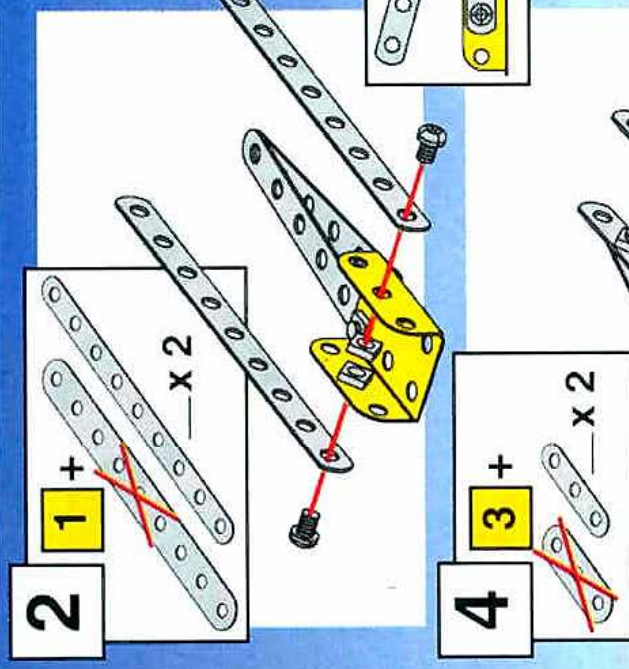
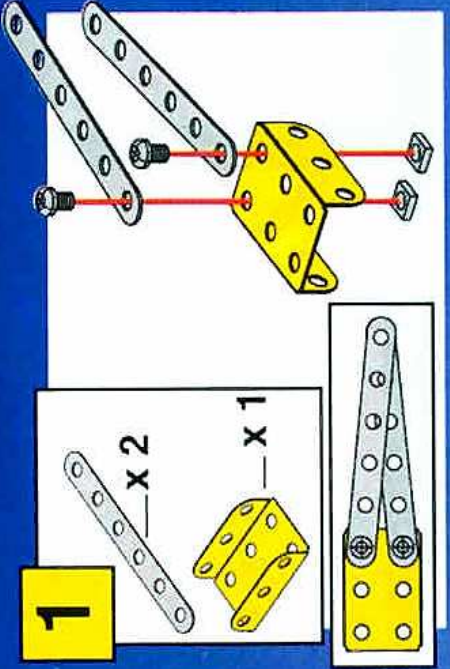



14



x 2



x 2

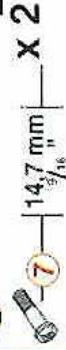

14.7 mm

x 2



1

7



15

14 +

x 2

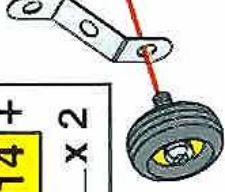

16

12 + 13 + 15 +

x 2



x 2

12 mm

x 2

3

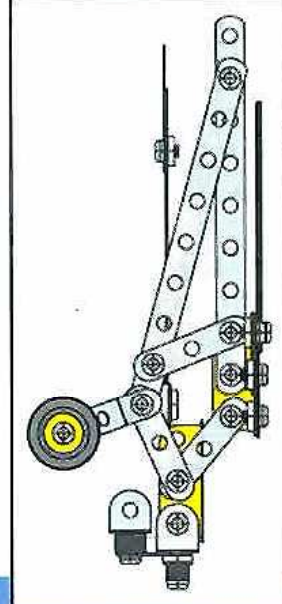

17

16 + x 2

x 1



x 1

19 mm

x 1

2

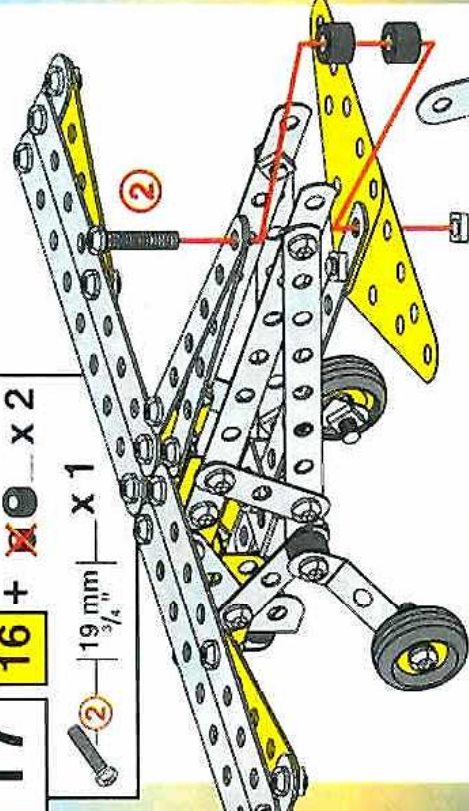

18

17 + x 2



x 1

x 1



x 1

x 1

19 mm

x 1

x 1

2

3/4"

x 1

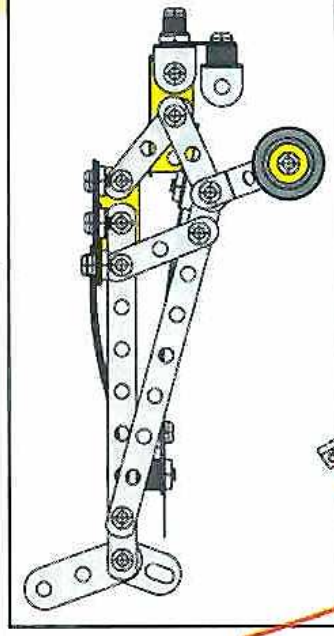

19

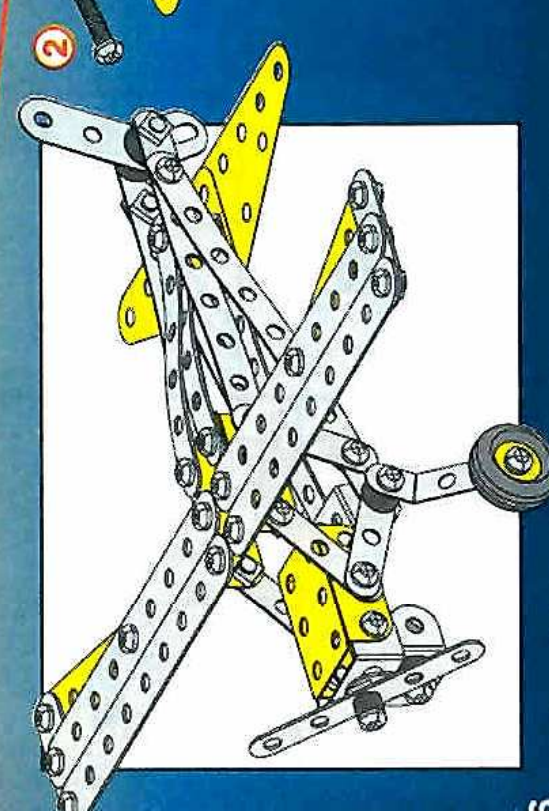



6

5+

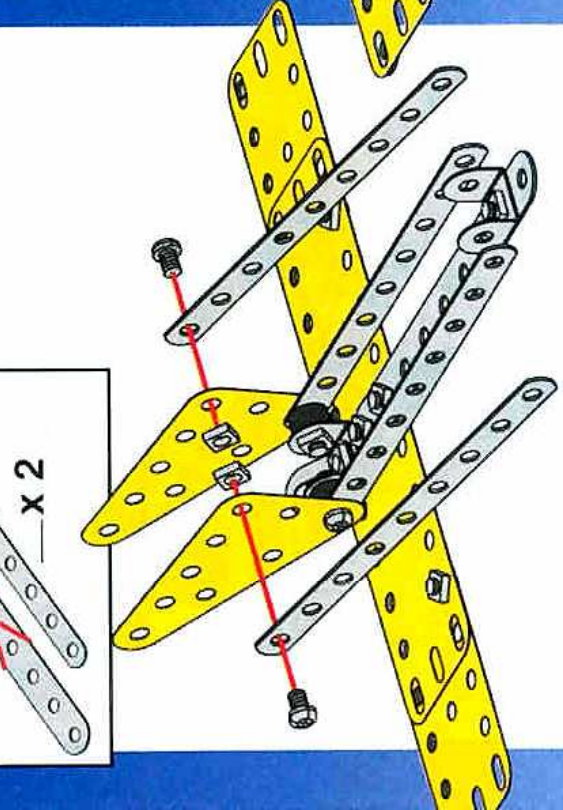
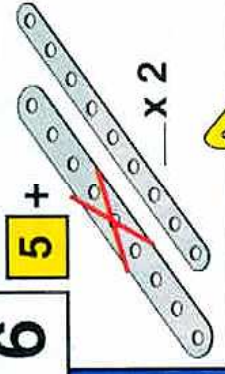

7

6+

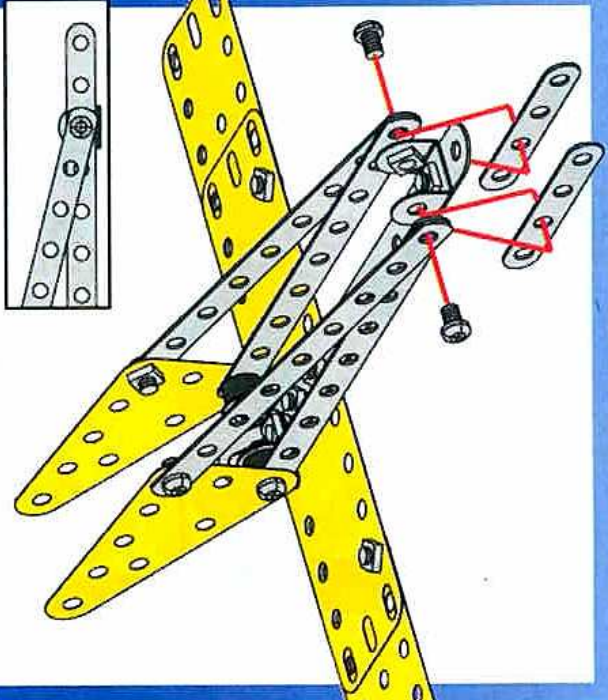
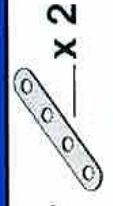

8

~~5~~ x 1

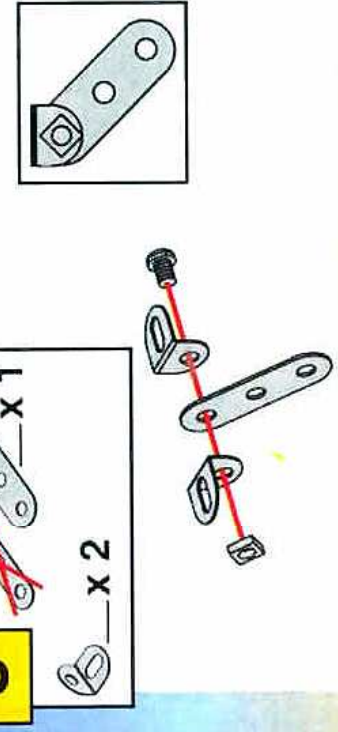
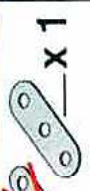

9

8+

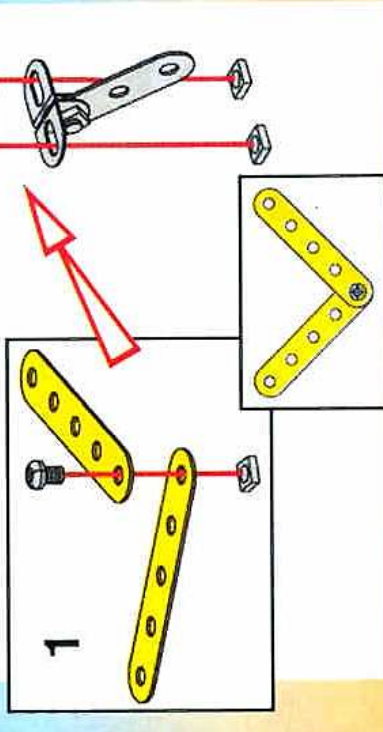
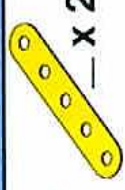

10

7+9+

~~5~~ x 2

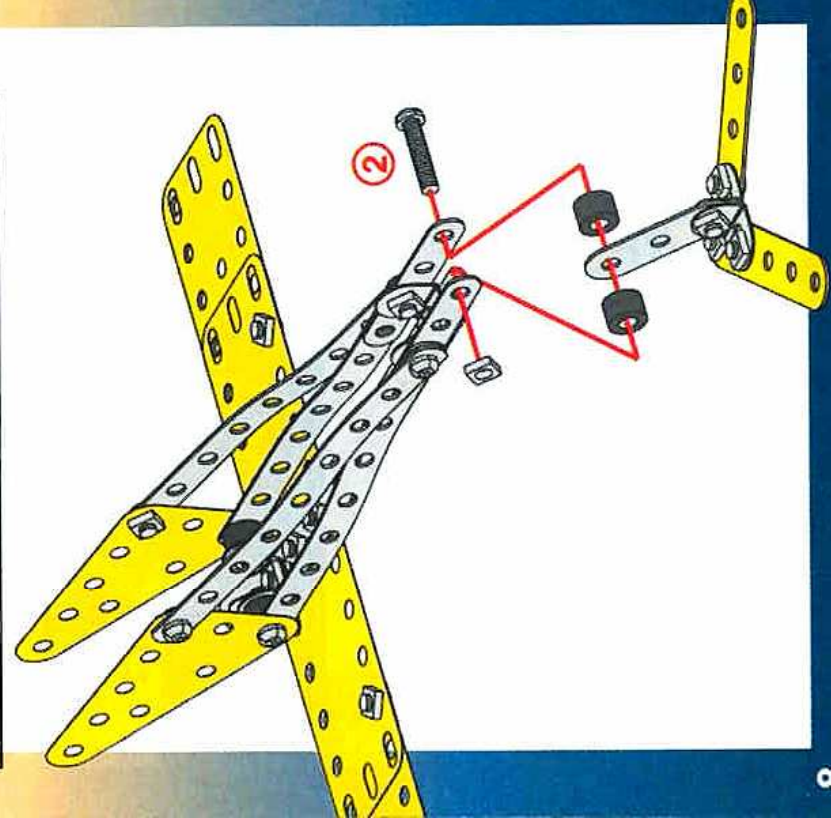
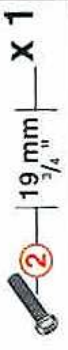

11

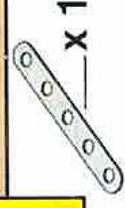

x 1

14,7 mm  $\frac{9}{16}$  x 1

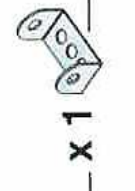

x 1

~~5~~ x 1

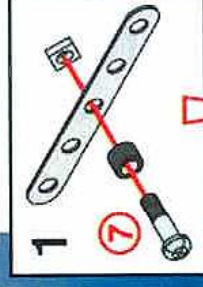

1

7

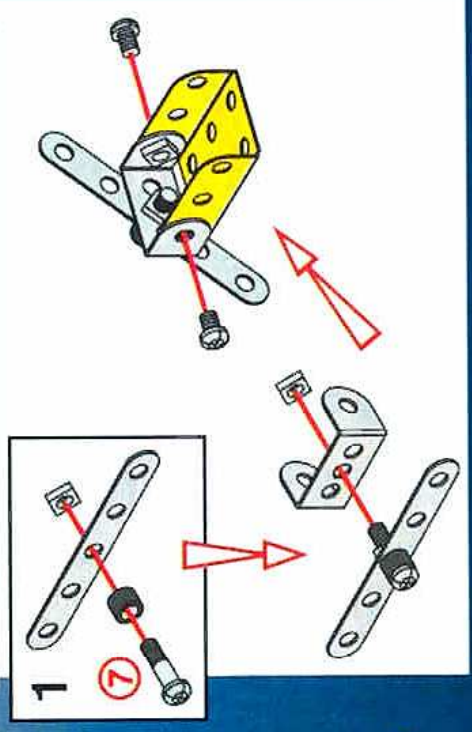



12

10 + 11

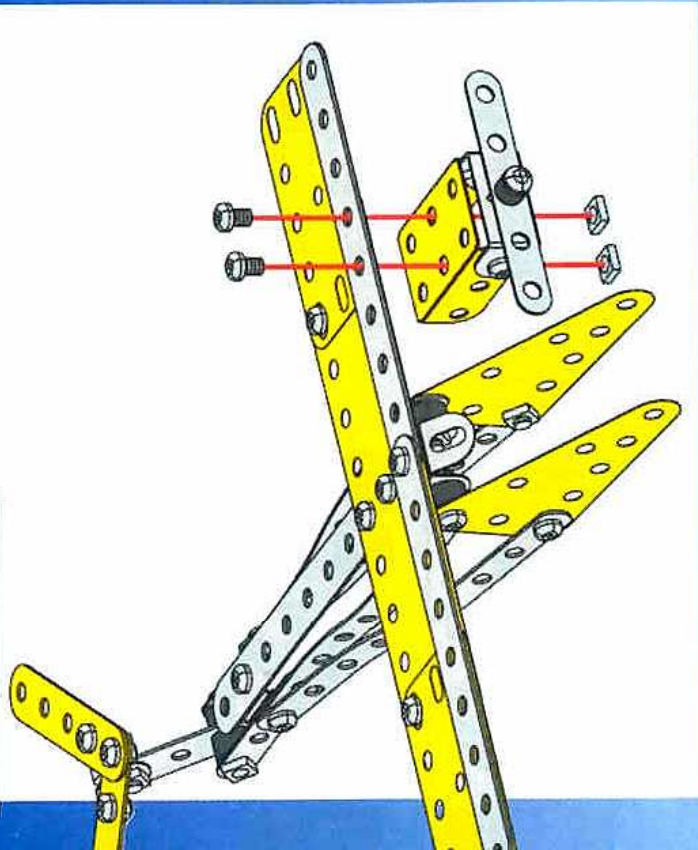

13

- x 1
- x 1
- x 1
- x 1
- x 1

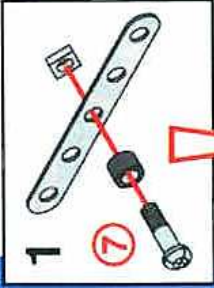

1

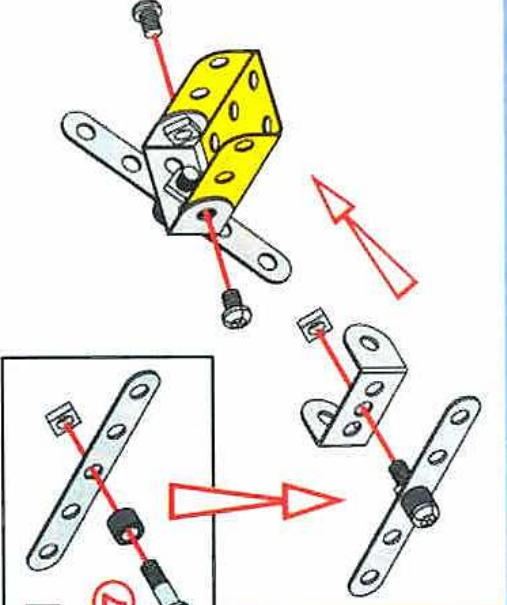

14

12 + 13

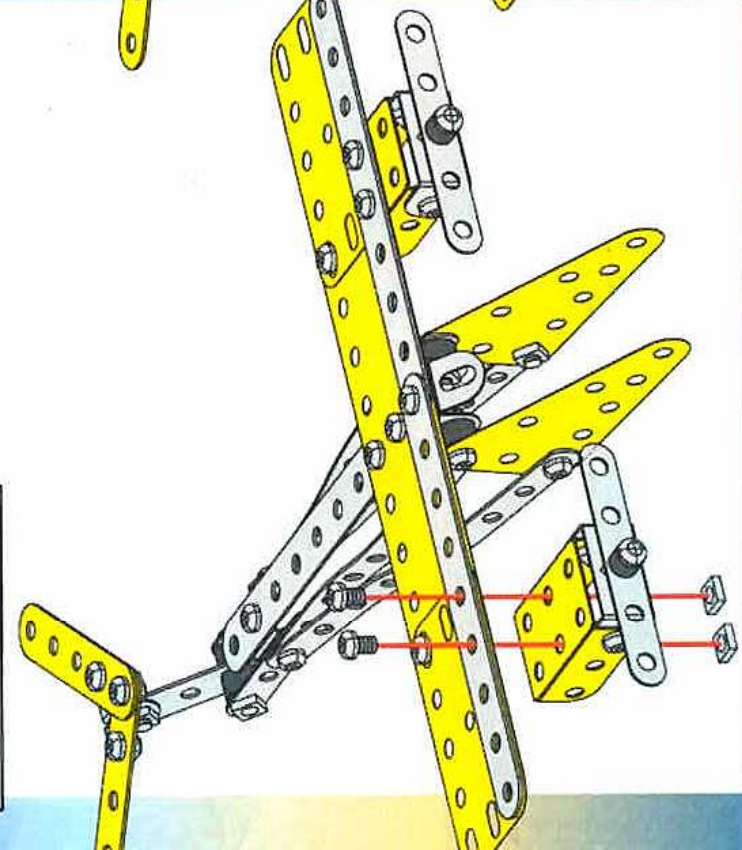

15

- x 2
- x 2

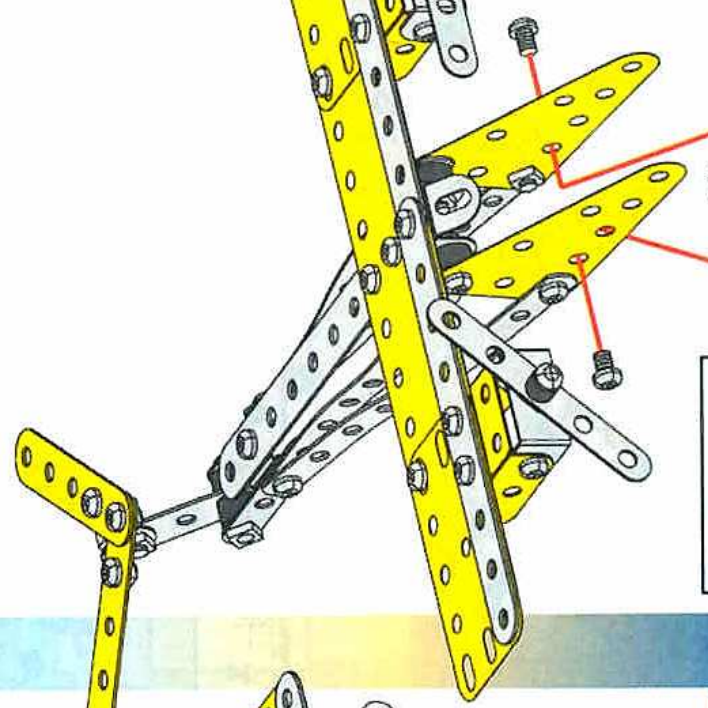
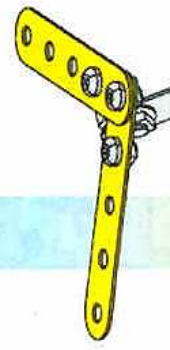

16

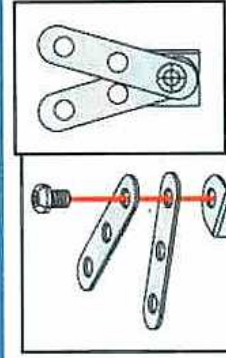

- x 2
- x 1
- x 2

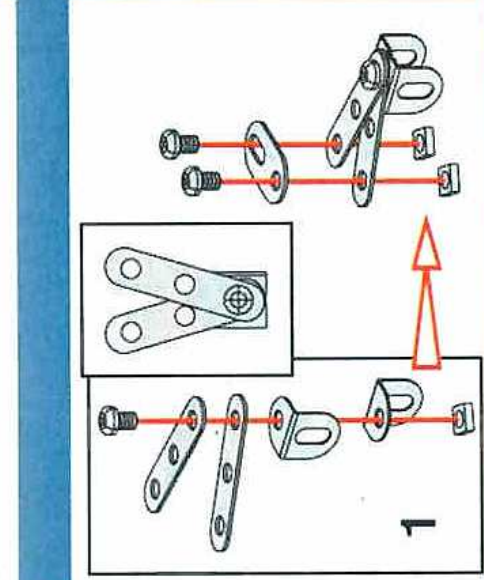

1





**17**

**15** + **16** +  x 1  **2** | 19 mm |  $\frac{3}{4}$ " | x 1

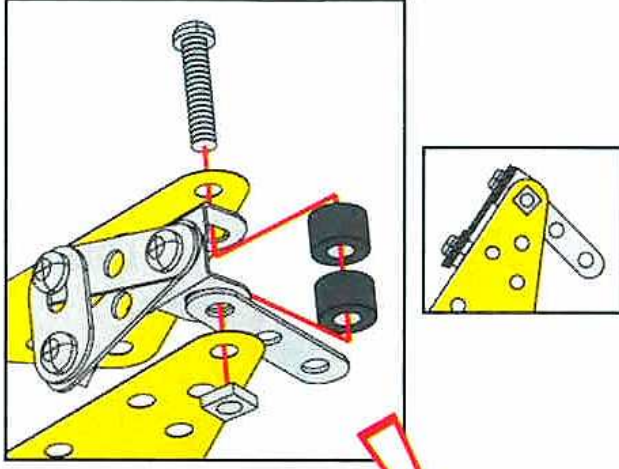
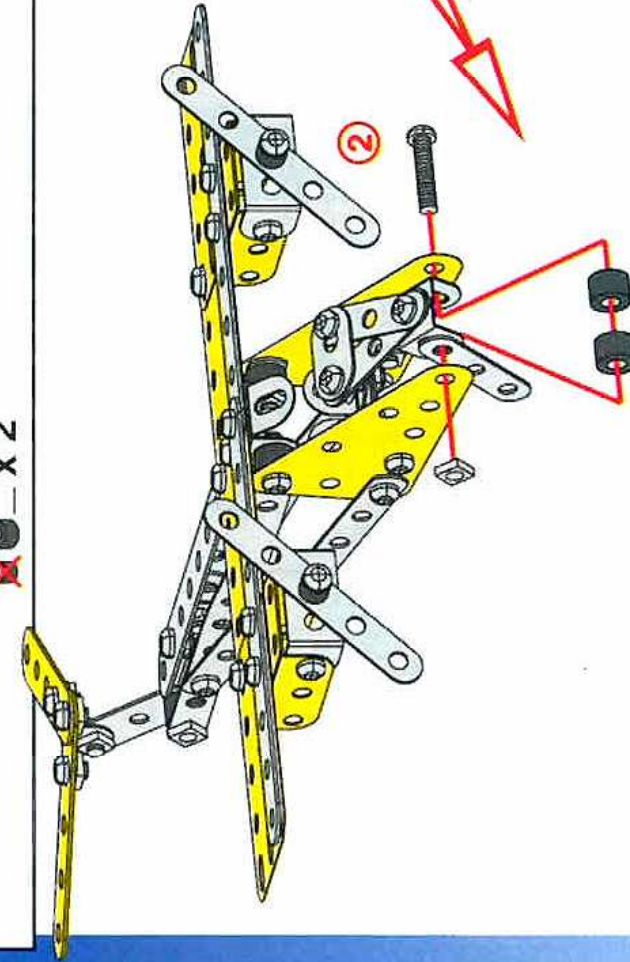
 x 2

**18**

 x 3

 x 3 | 14,7 mm |  $\frac{9}{16}$ " | x 3

**1****19**

**18** +  x 2

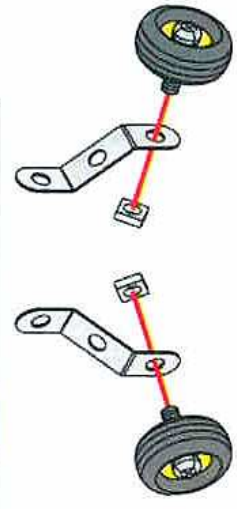
**20**

**19** +  x 2 | 12 mm |  $\frac{1}{2}$ " | x 2

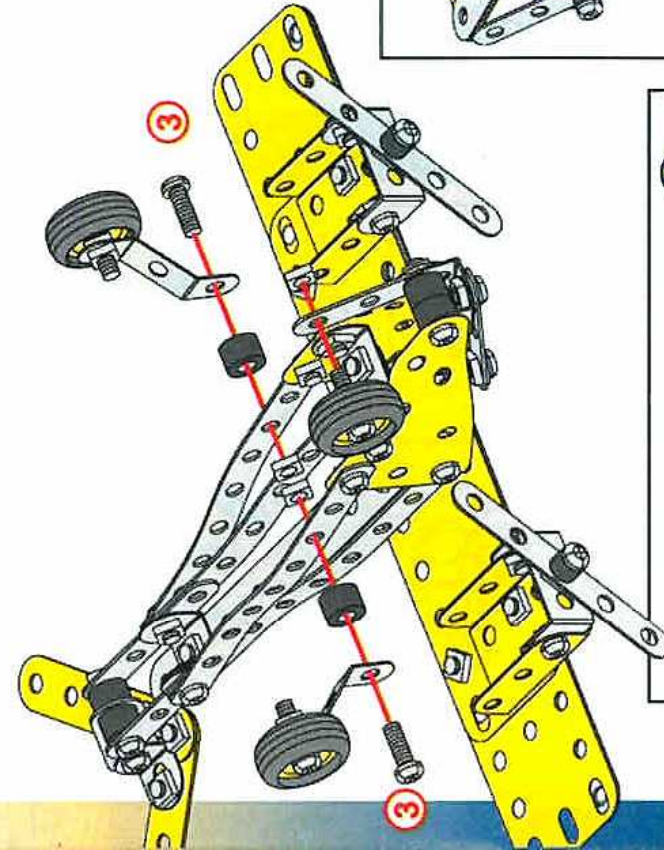
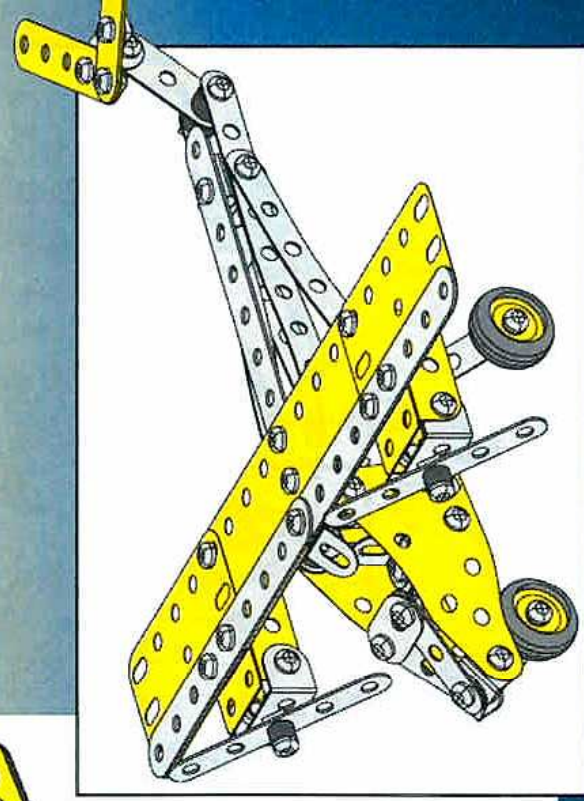
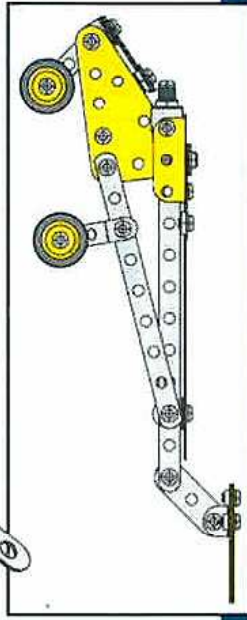
**3**

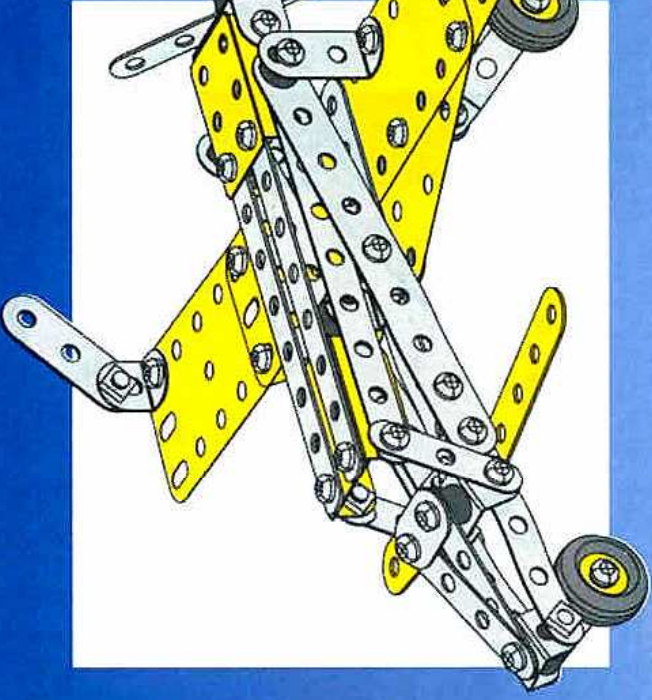

1

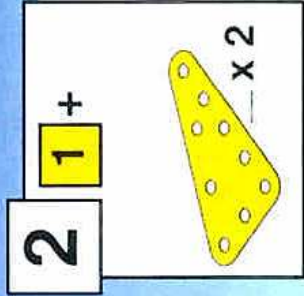
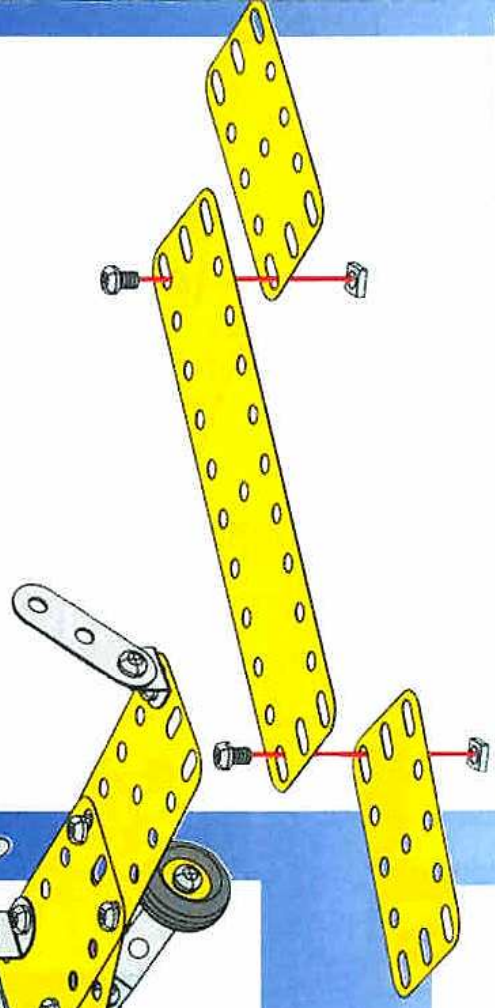
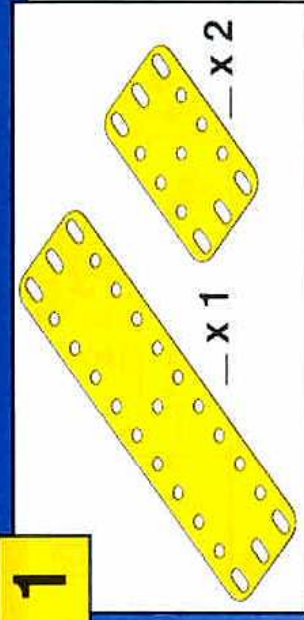

2

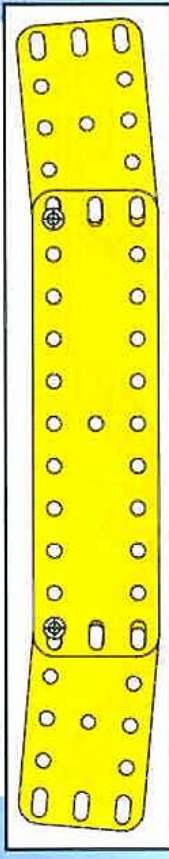
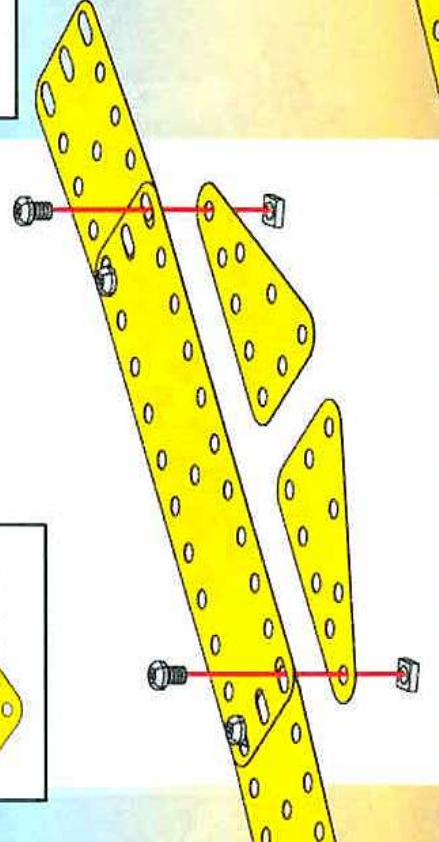



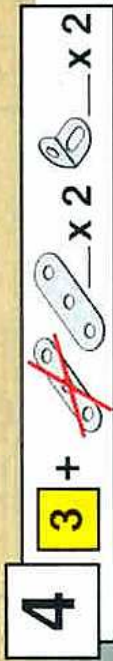
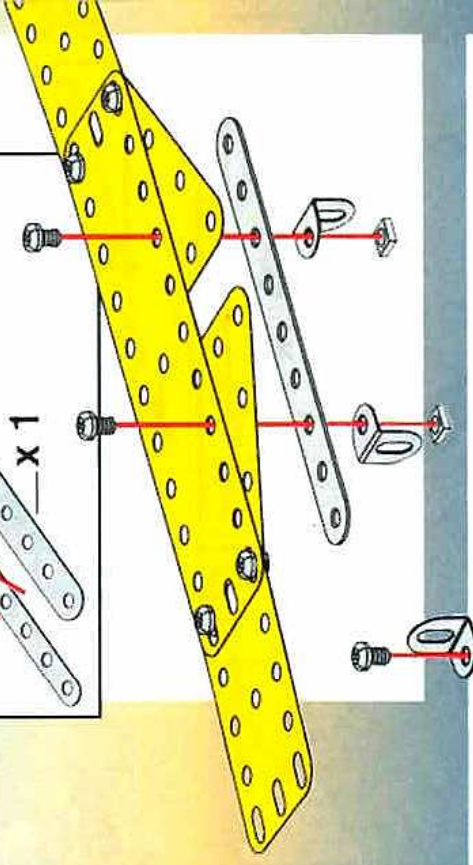
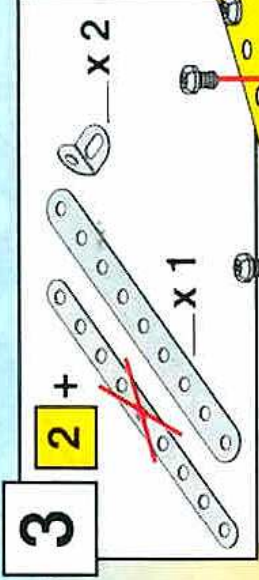

3

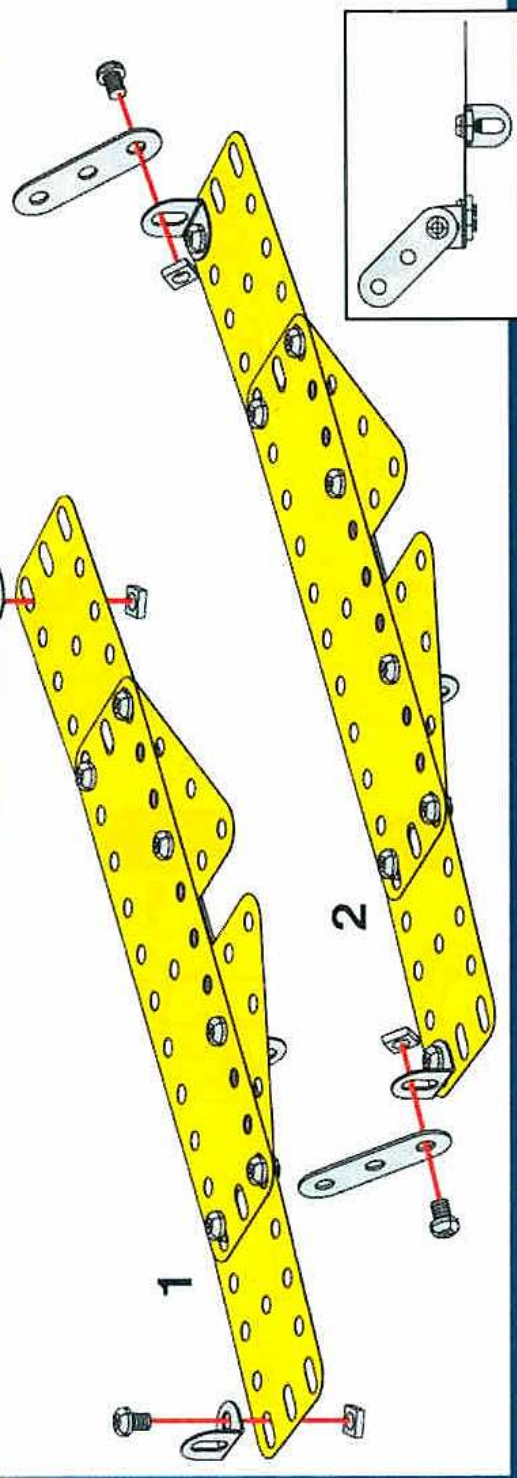

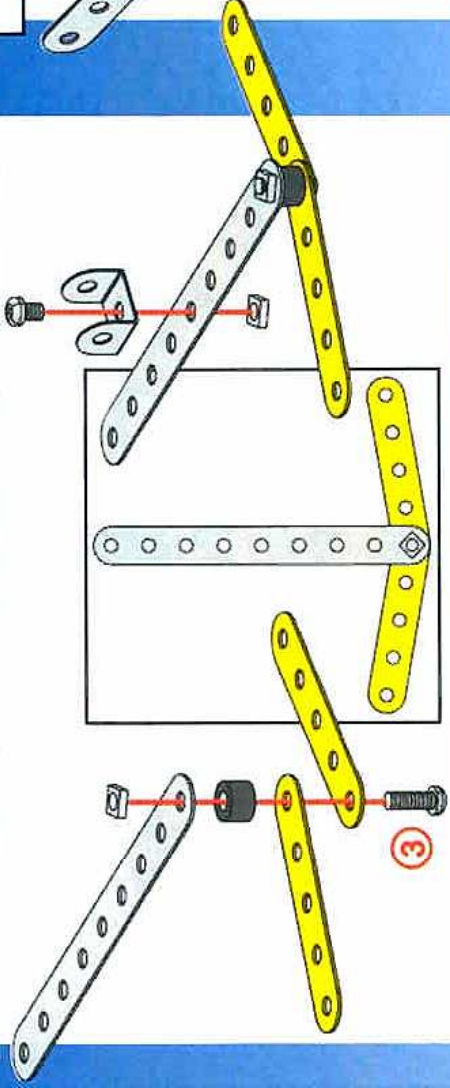
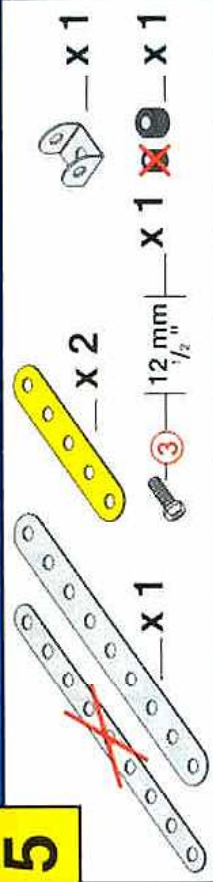
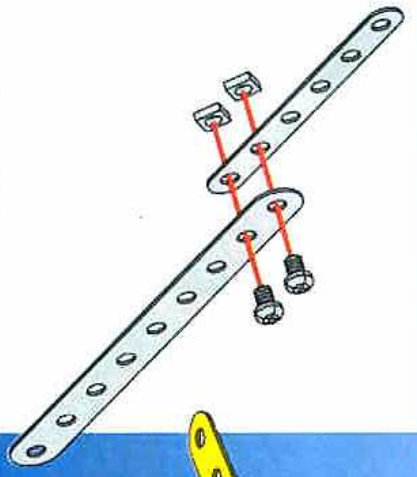
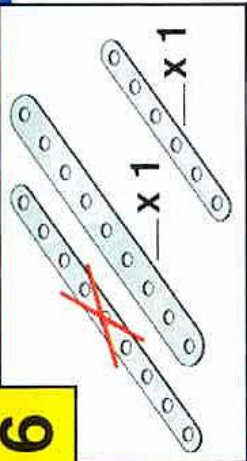
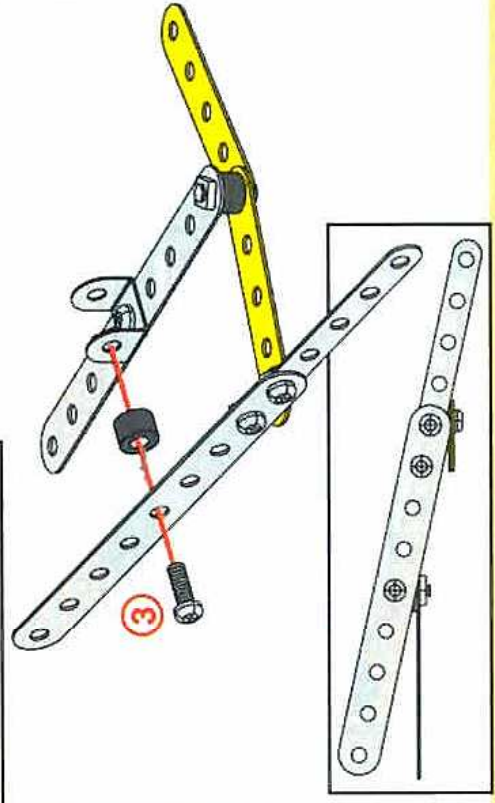
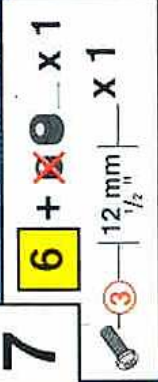
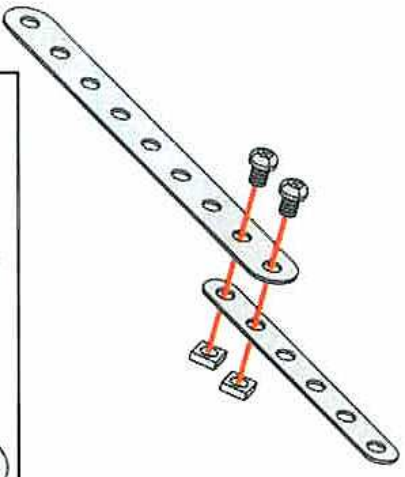
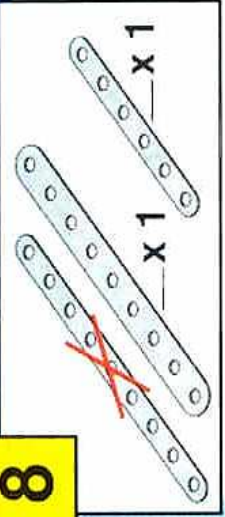
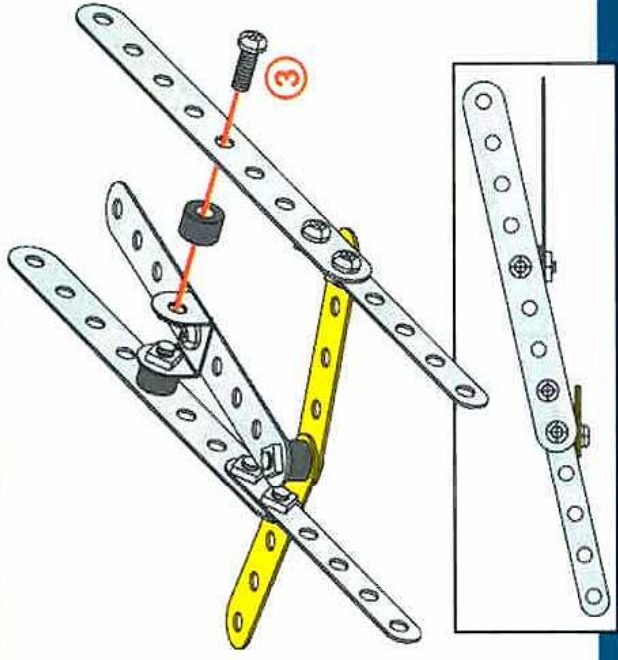
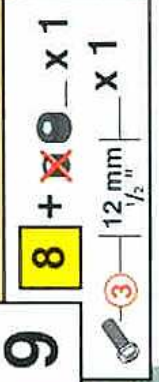
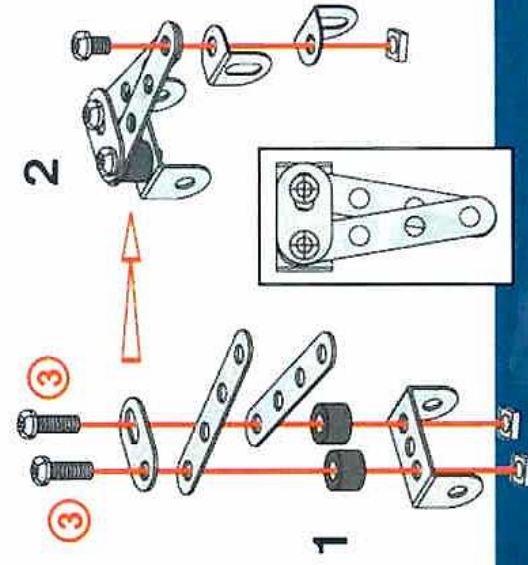
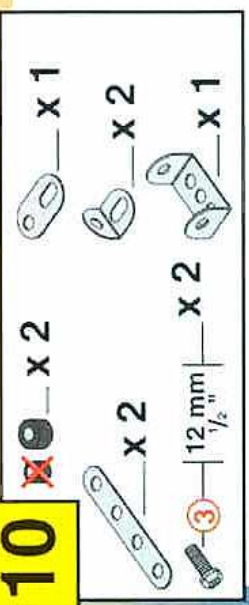
4



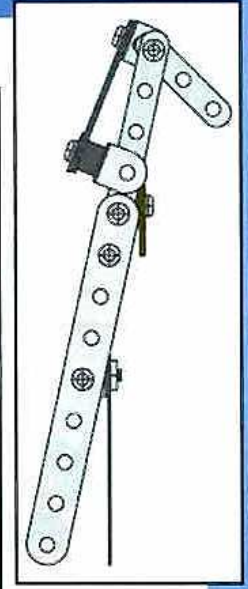
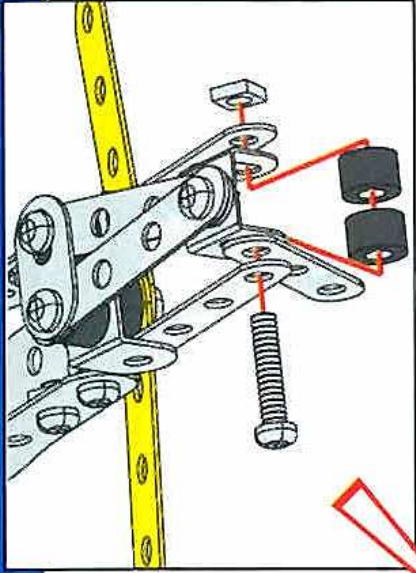
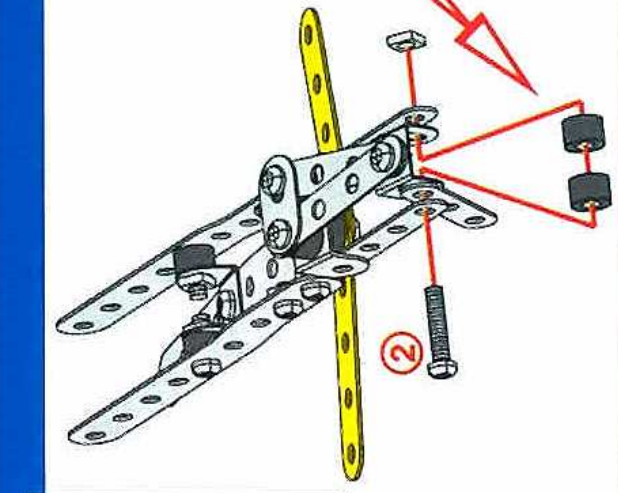

**5****6****7****8****9****10**

**11** **9** + **10** +  
 x 1  
 x 2  
 x 1

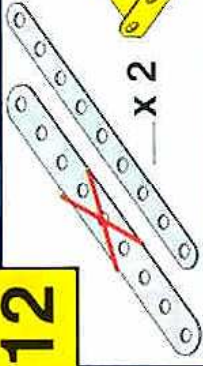
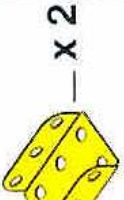

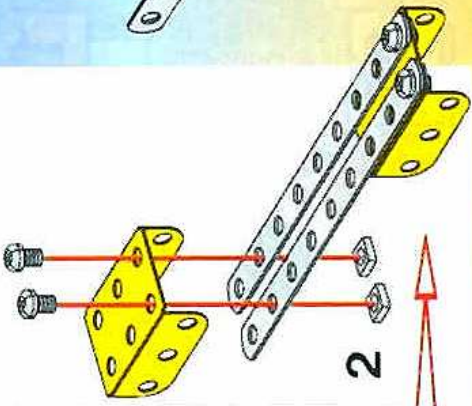
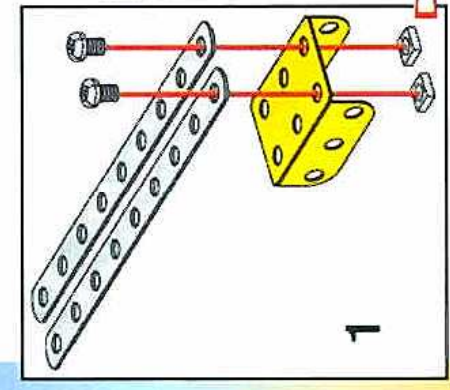
**12**  x 2  
 x 2

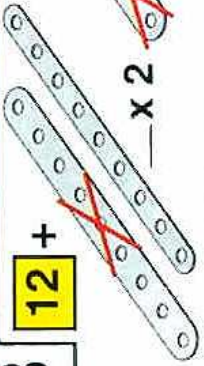

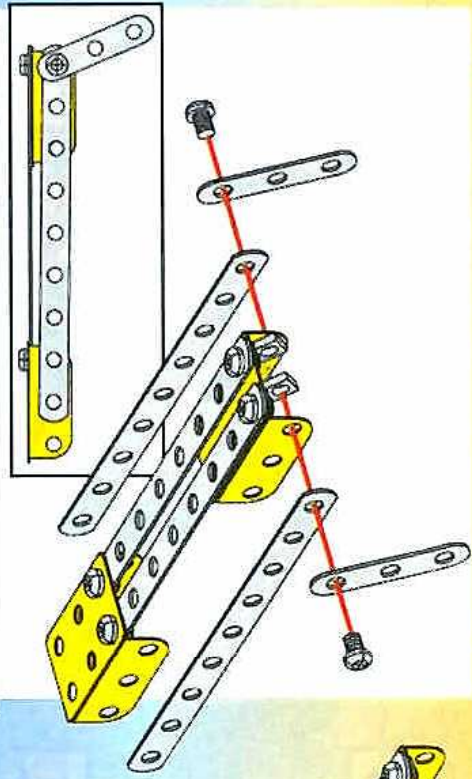

**13** **12** +  
 x 2  
 x 2

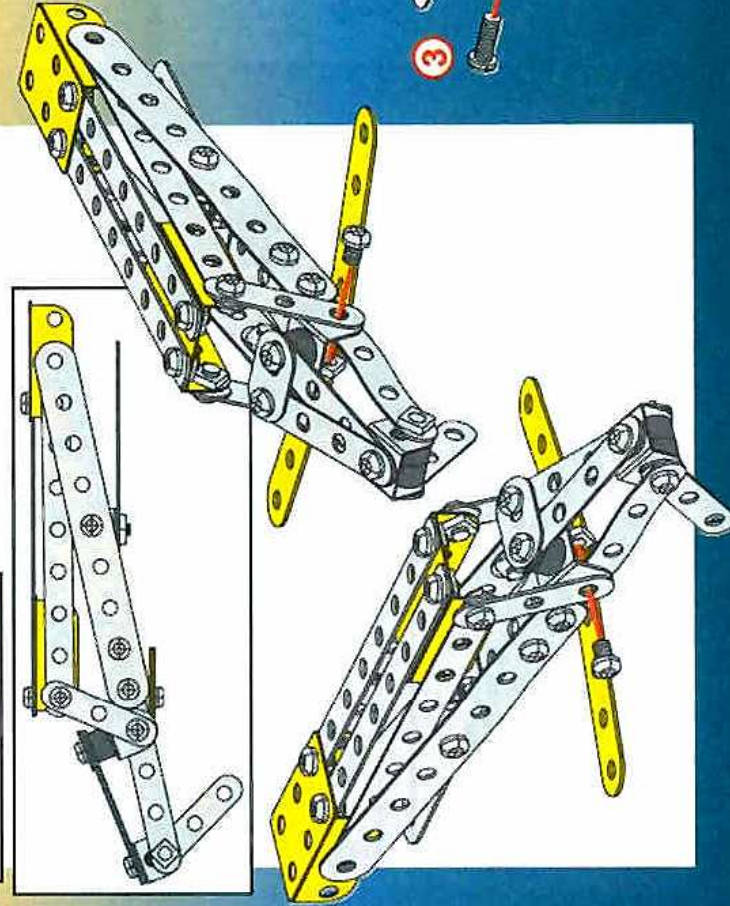

**14** **11** + **13**



**15** **14** +  x 2  
 x 2  
 x 2

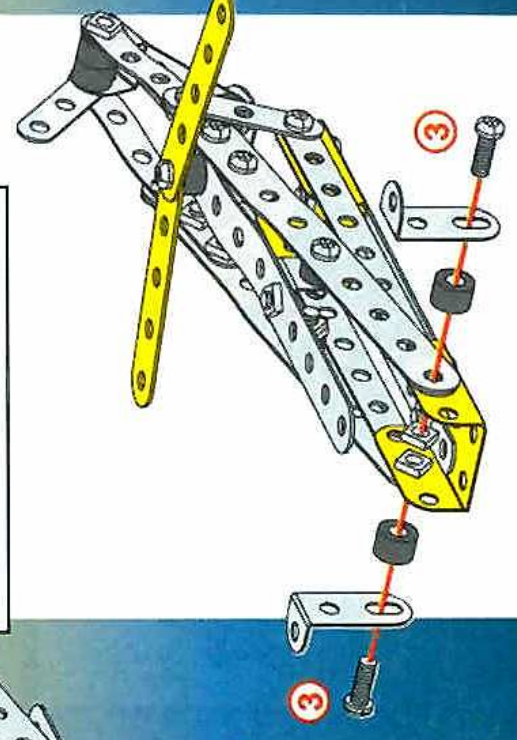

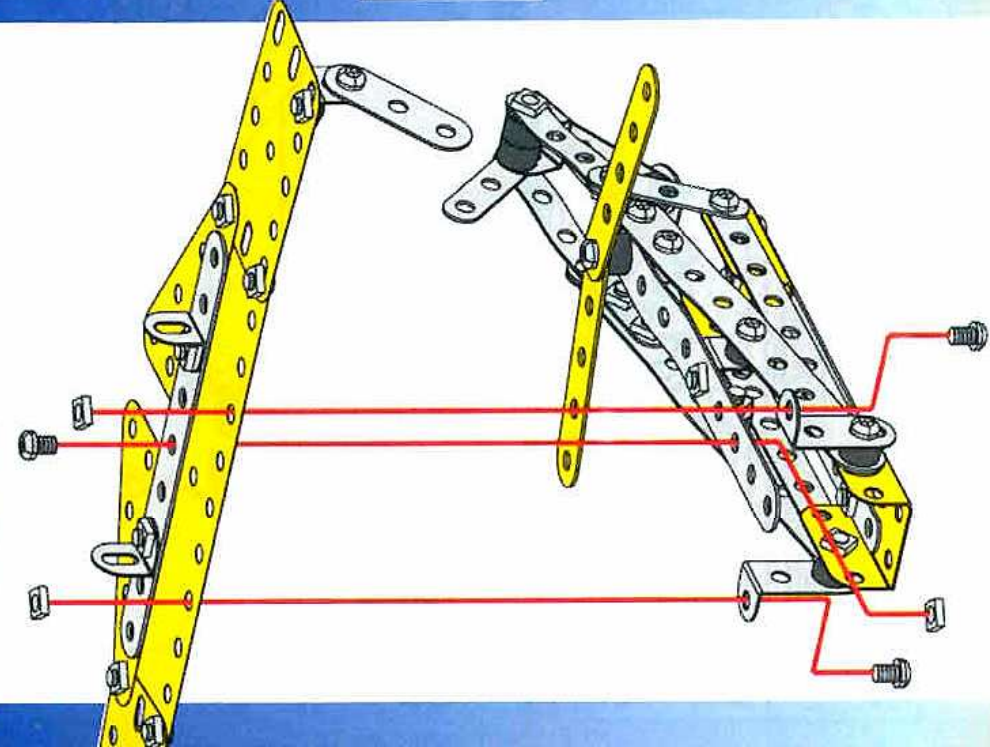

16

4 + 15



17

16 +  x 1  x 1  
 x 1   $14,7 \frac{mm}{\frac{16}{10}}$  x 1

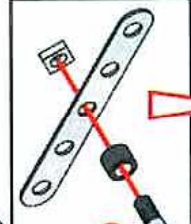
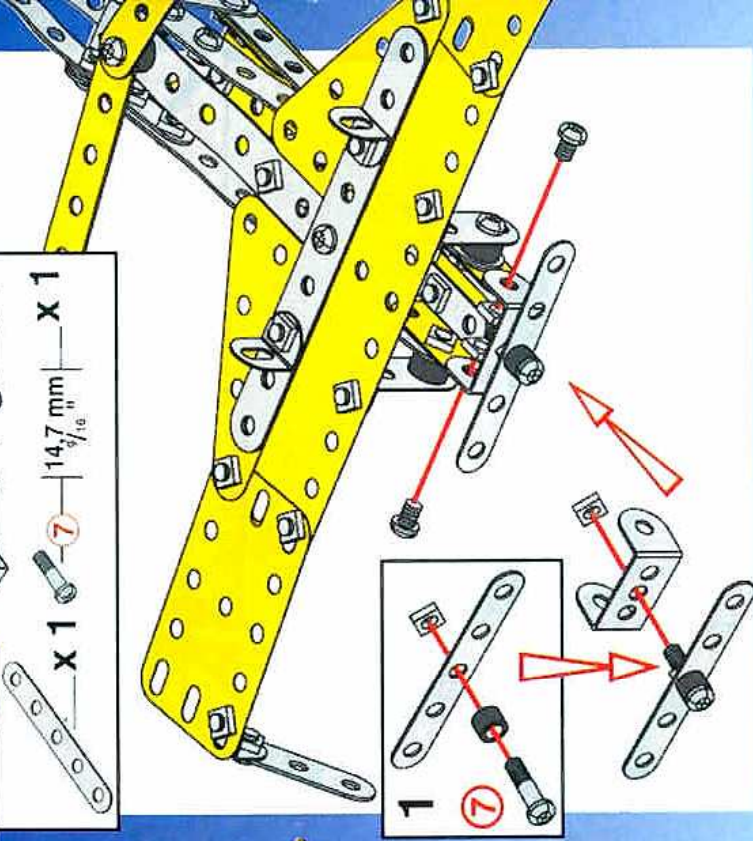

18

x 3  x 3  
 $14,7 \frac{mm}{\frac{16}{10}}$  x 3

1   



19

18 +  x 2

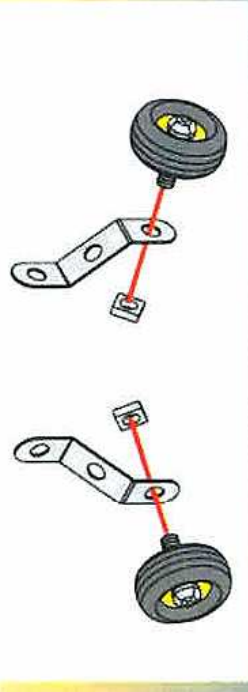

20

17 + 19

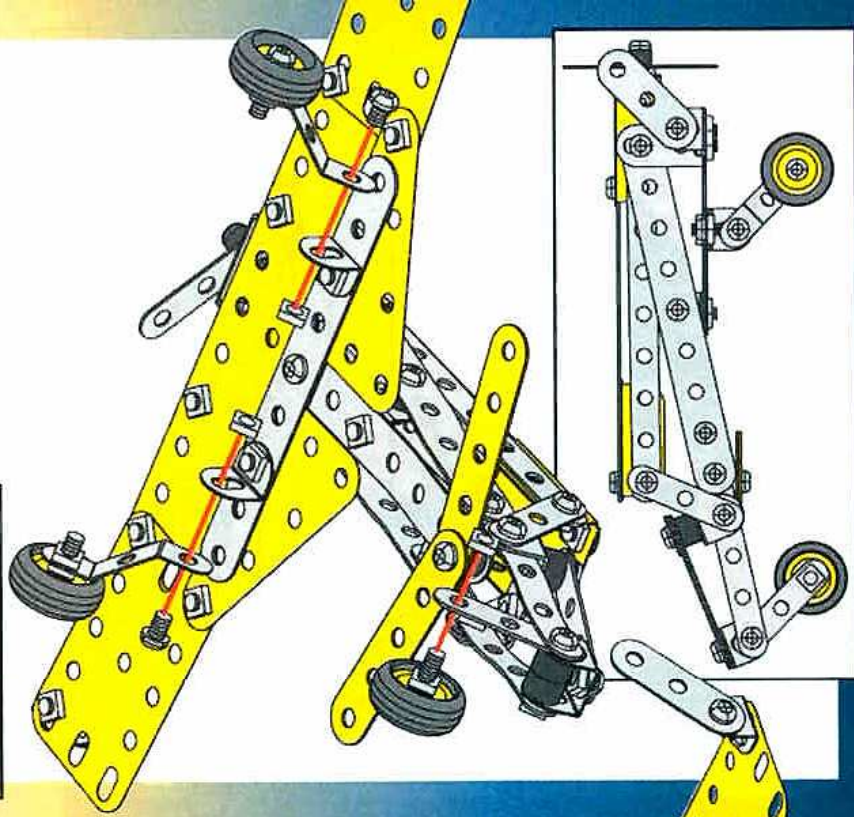

1

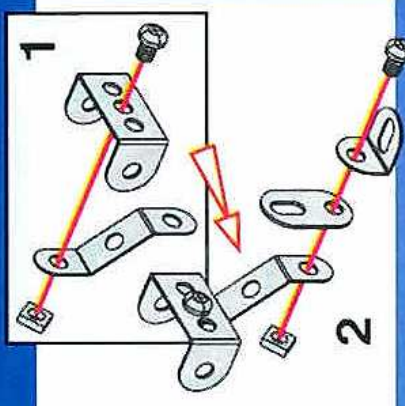
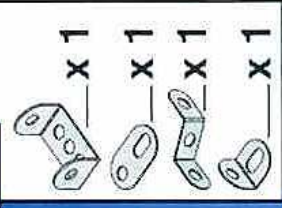

2

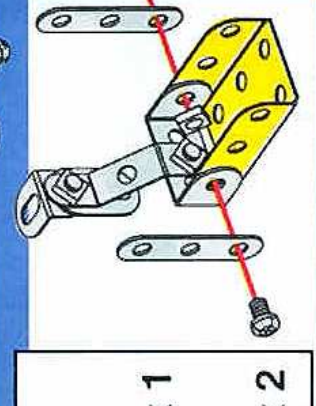
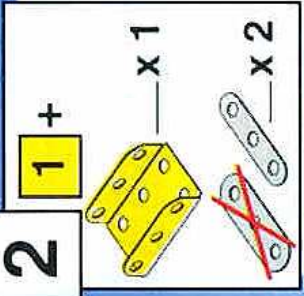

3

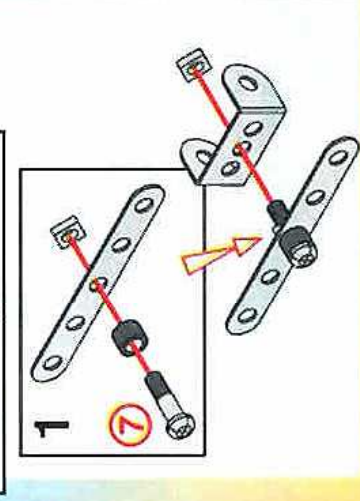
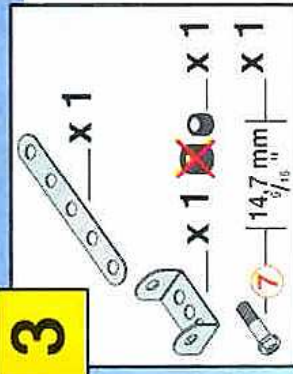

4

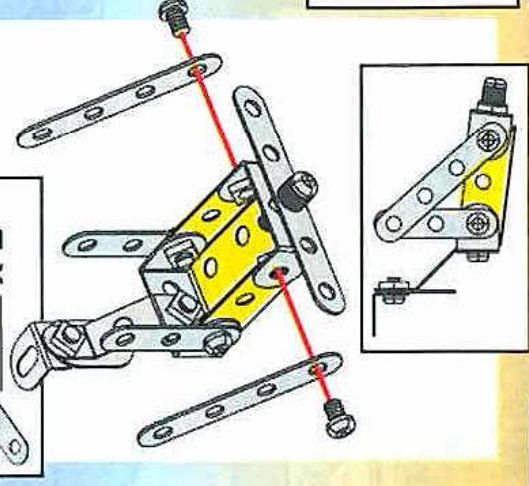
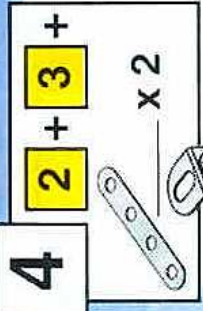

5

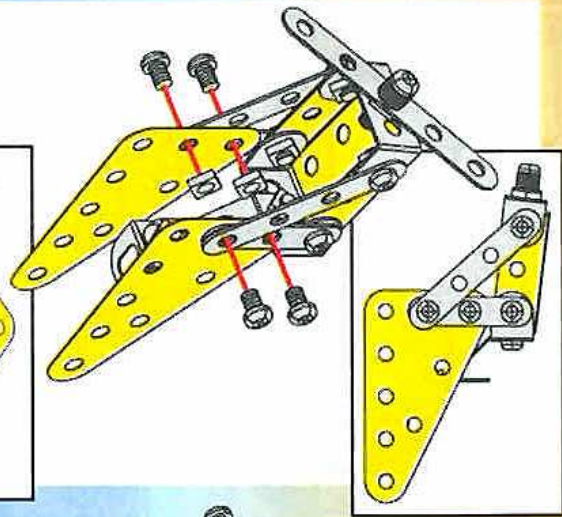
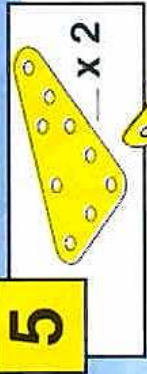

6

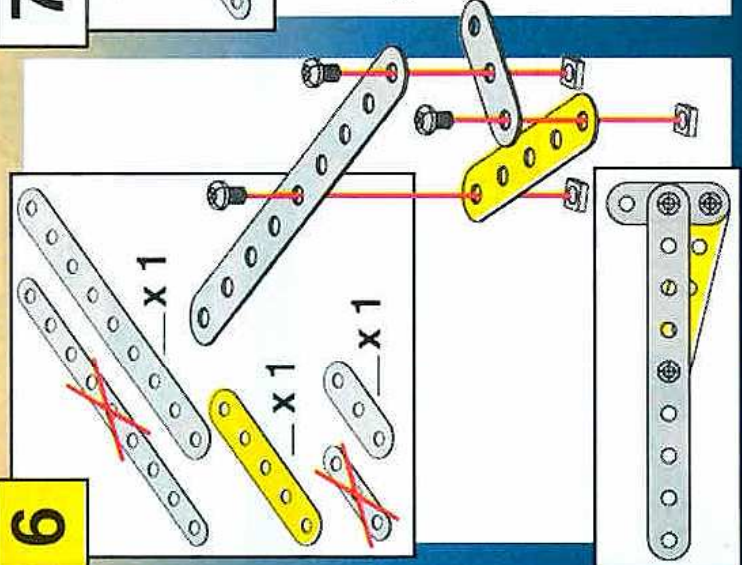
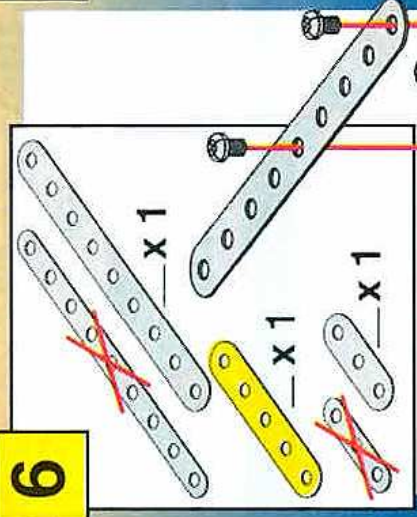

7

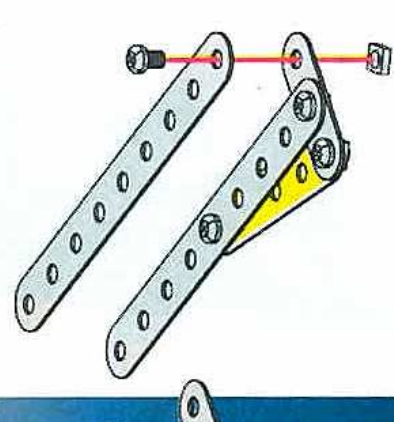
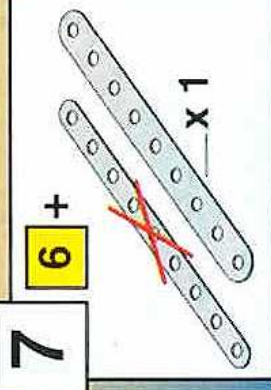

8

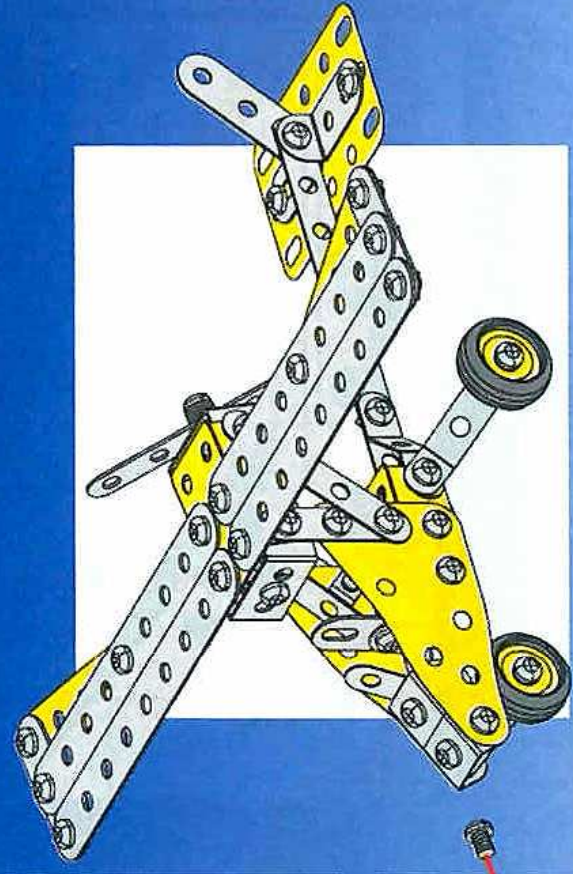
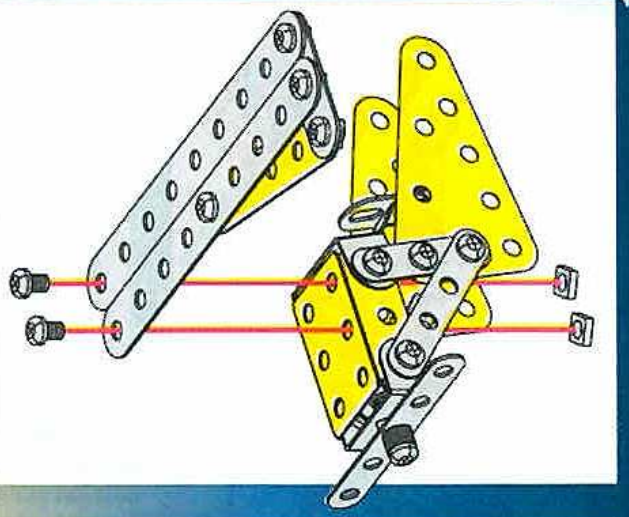

9

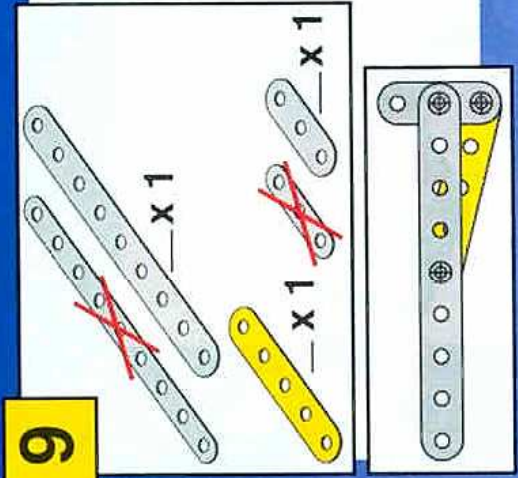

10

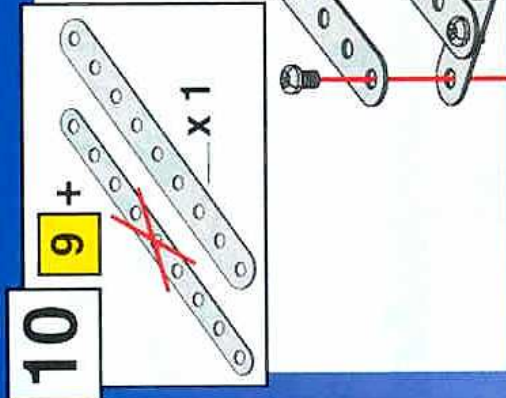

11

8 + 10

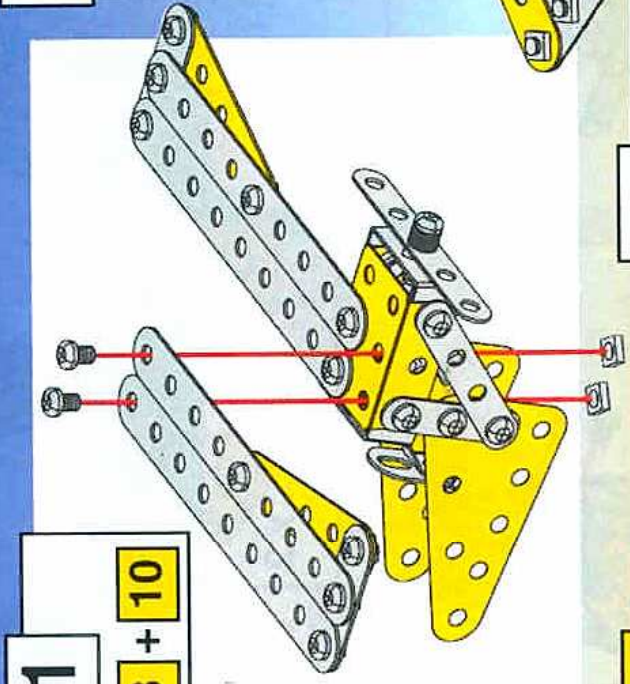

12

11 + x1

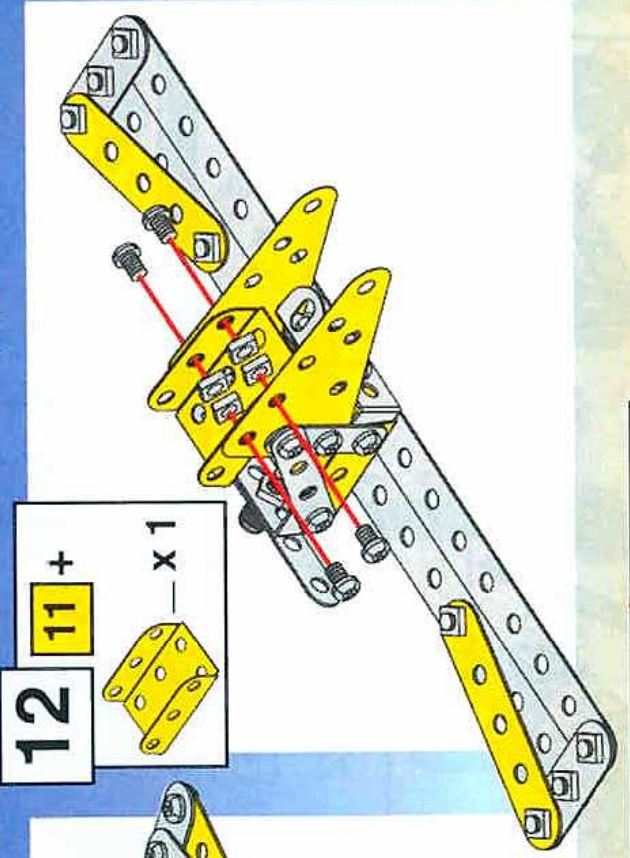

13

x1  
x2

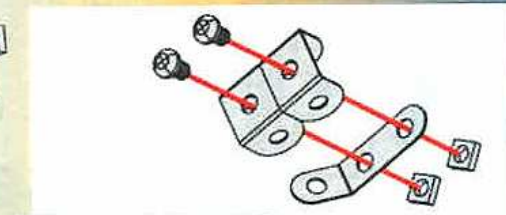

14

12 + 13 + x1

x1

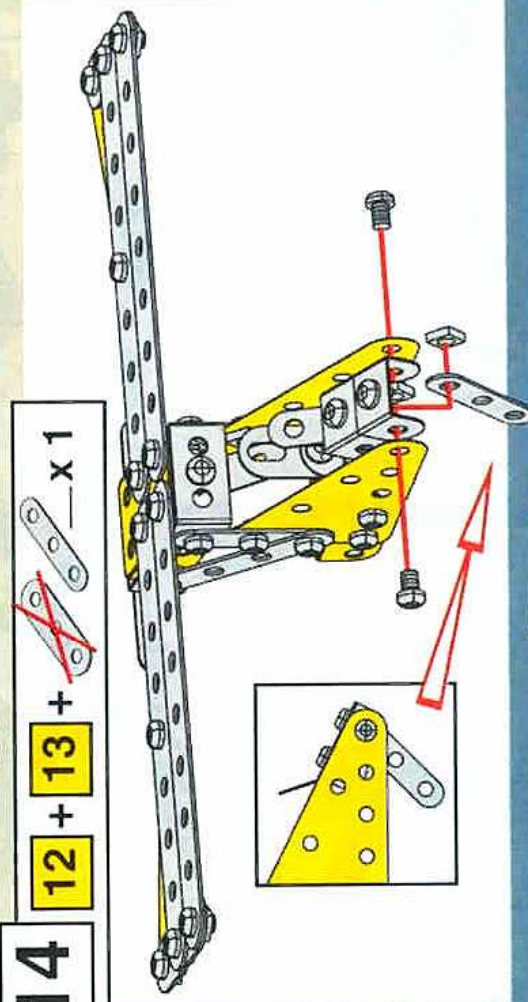

15

x1  
x1  
x2

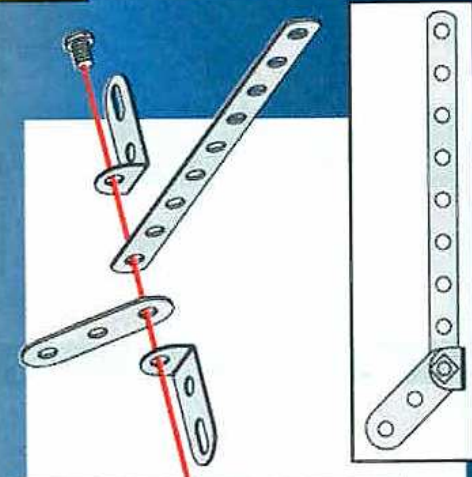

16

x1

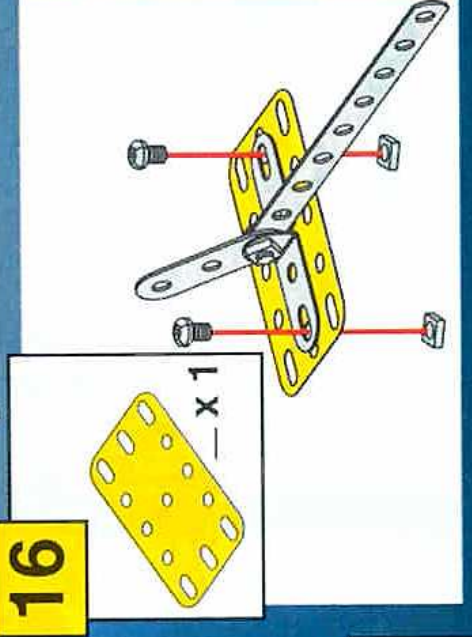



17

14 + 16 +



x 1



x 2

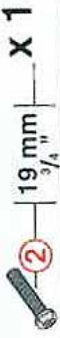

x 1

19 mm

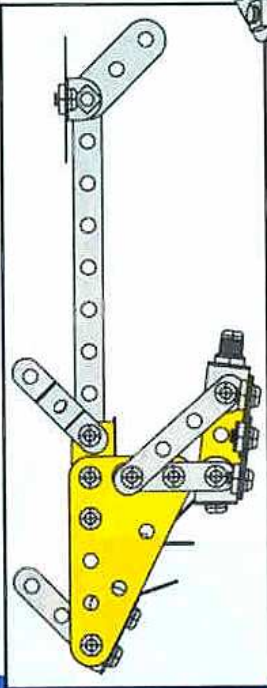

18

x 2

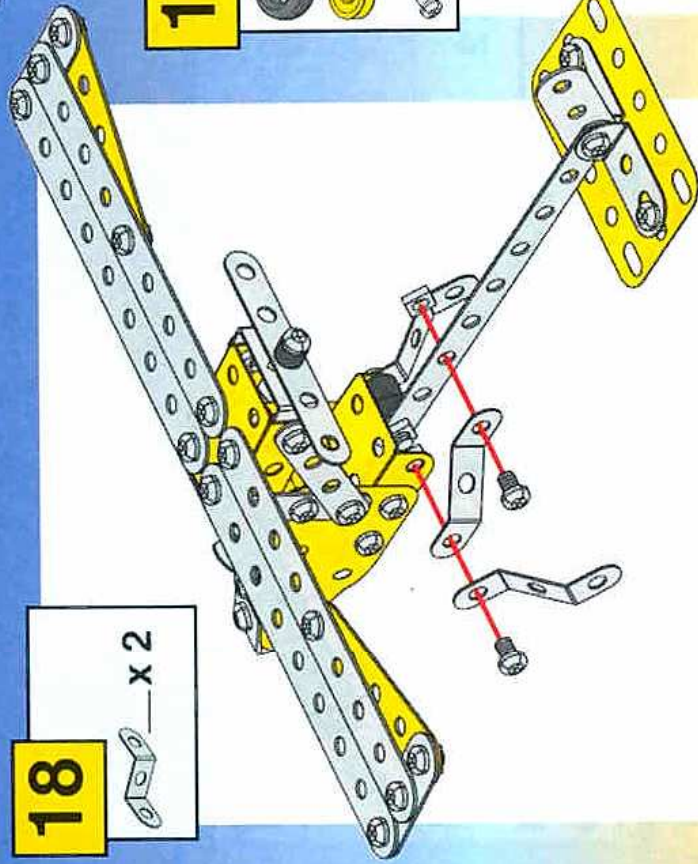

19

x 3



x 3



14,7 mm

x 3



1



20

18 + 19

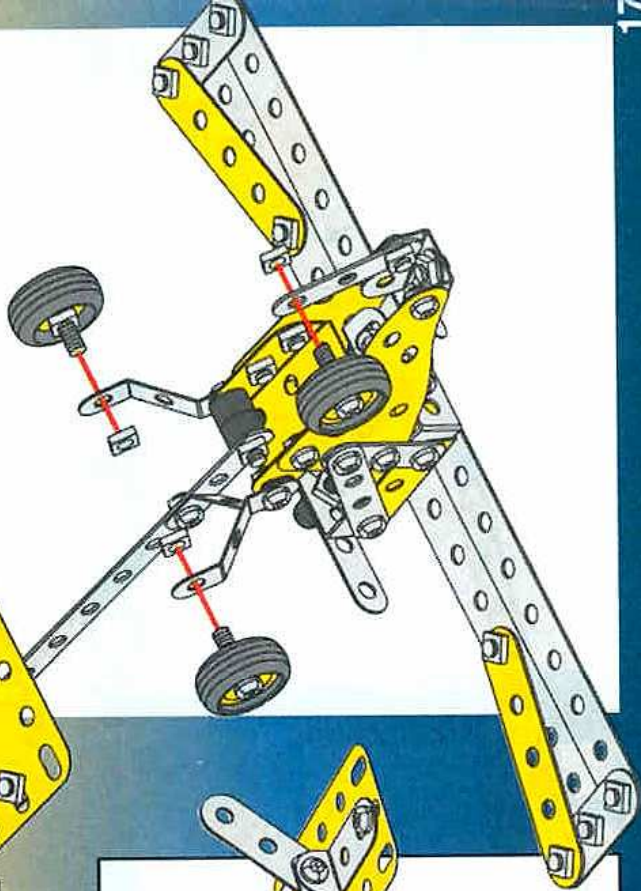
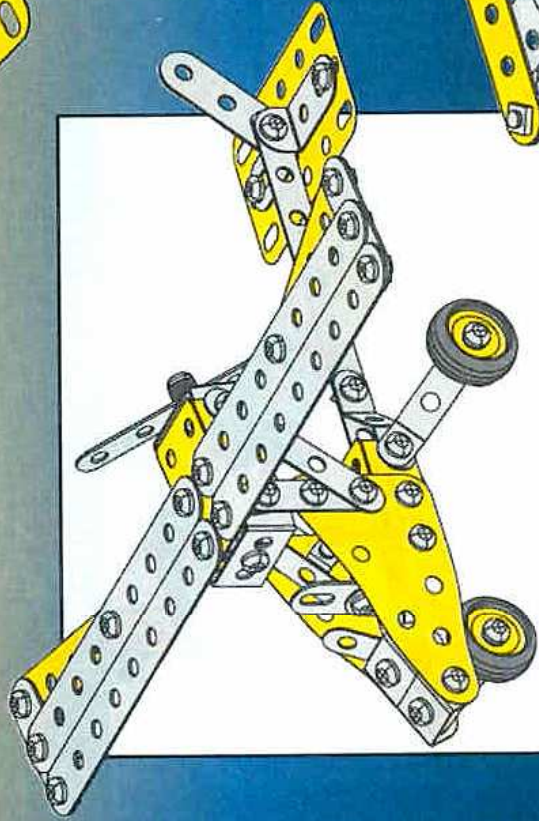
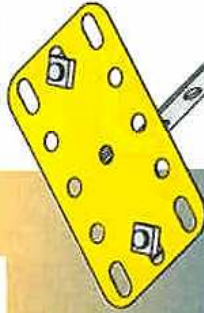
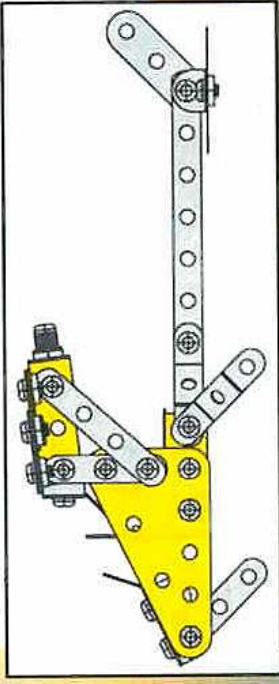

**1**

x1

x1

**2**

x1

x2

**3**

1 + 2 +

x1

**4**

x4

x2

**5**

3 + 4

**6**

x1

x1

x1

**7**

6 +

x1

x1

**8**

x1

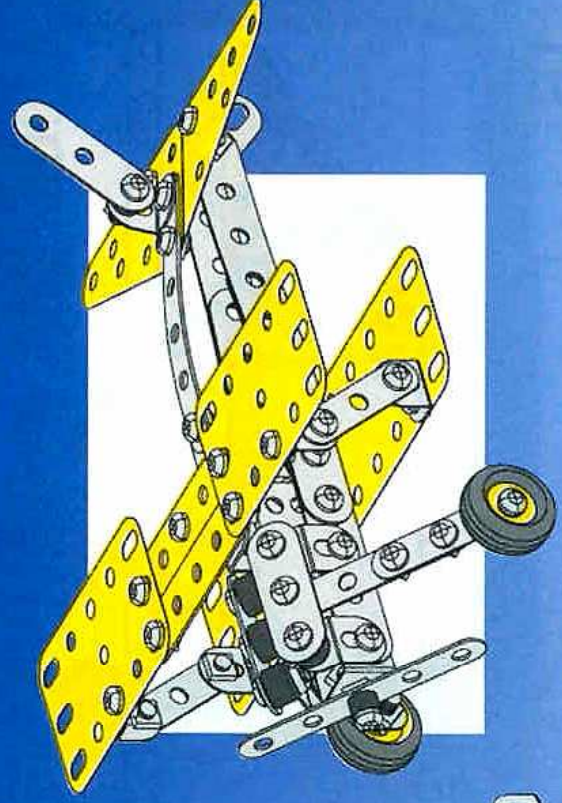

**9** **8** + **2** | 19 mm  $\frac{3}{4}$ " | x 1  
~~1~~ - x 2

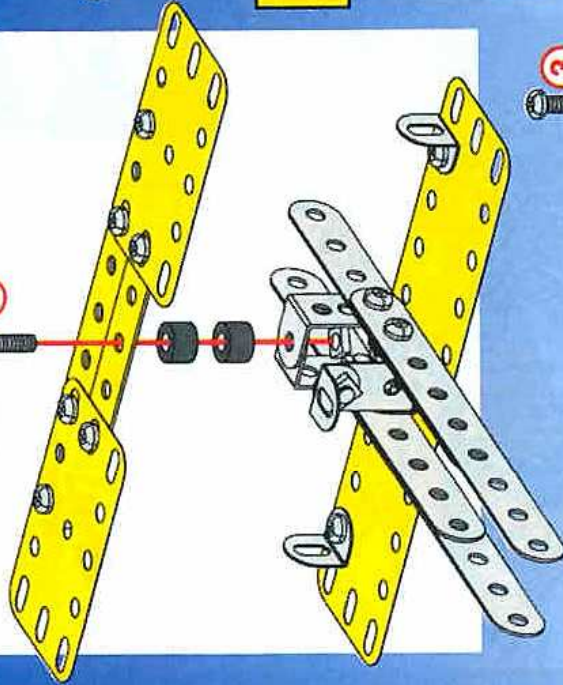

**10** ~~1~~ - x 2

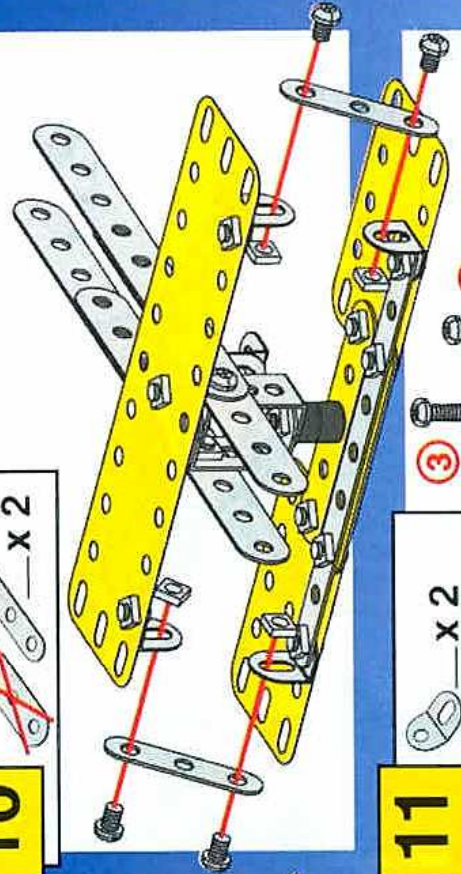

**11** ~~1~~ - x 2  
~~2~~ - x 1  
~~3~~ - x 2 | 12 mm  $\frac{1}{2}$ " | x 2

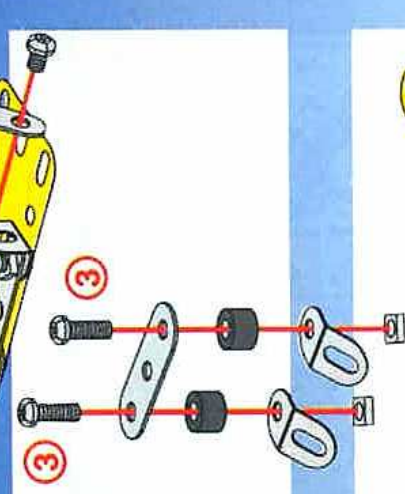

**12** **11** +  
~~1~~ - x 1  
~~2~~ - x 1  
~~3~~ - x 1 | 12 mm  $\frac{1}{2}$ " | x 1

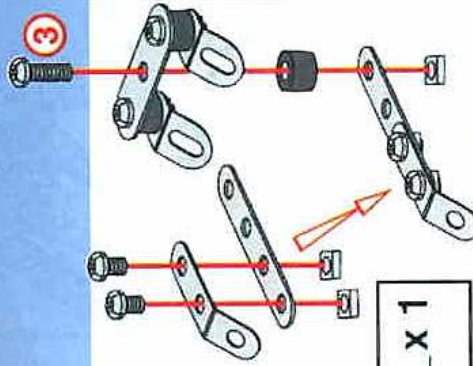

**13** **10** + **12** +  
~~1~~ - x 1

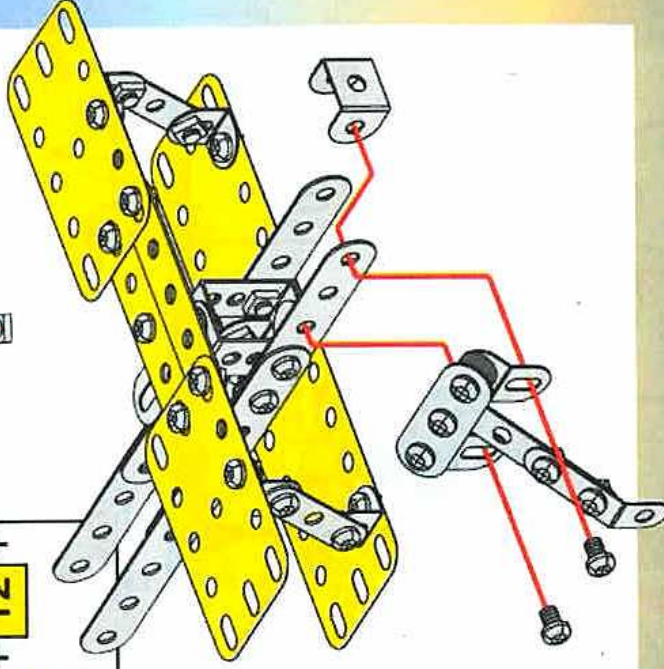

**14** ~~1~~ - x 2  
~~2~~ - x 1  
~~3~~ - x 2 | 12 mm  $\frac{1}{2}$ " | x 2

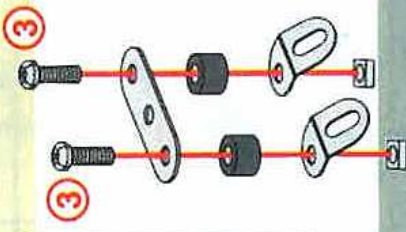

**16** **13** + **15**

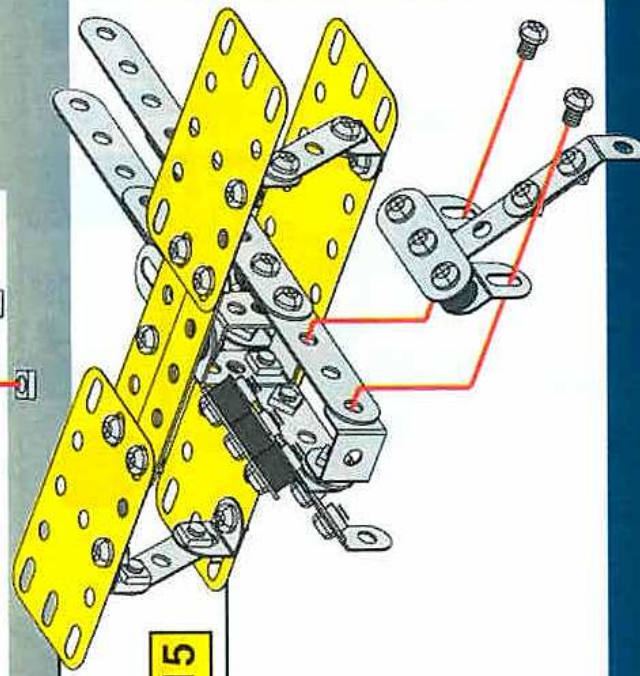

**15** **14** +  
~~1~~ - x 1  
~~2~~ - x 1  
~~3~~ - x 1 | 12 mm  $\frac{1}{2}$ " | x 1

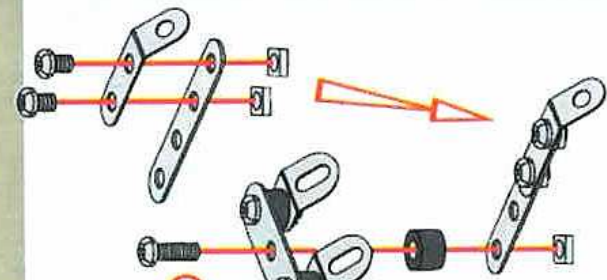

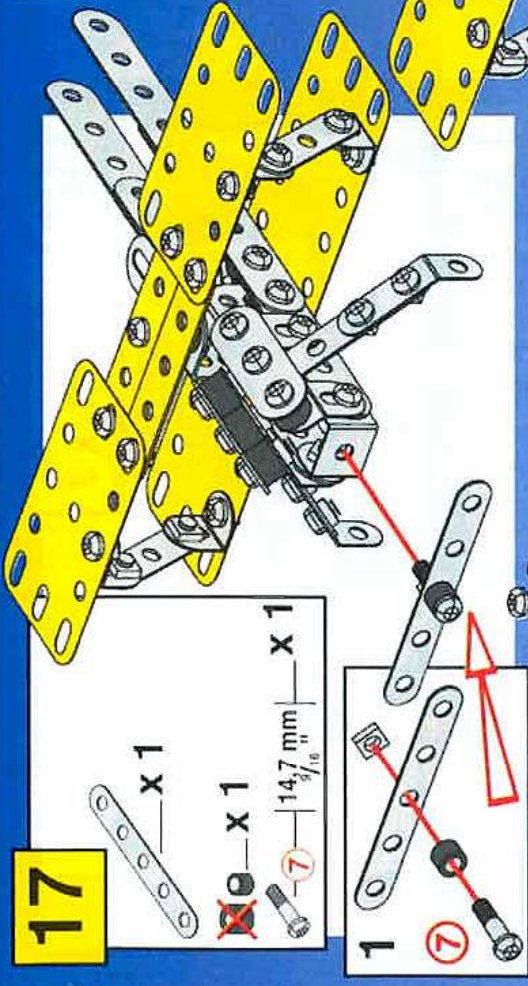

**17**

- x 1
- x 1
- x 1

- 18** + x 2
- x 1
- x 1

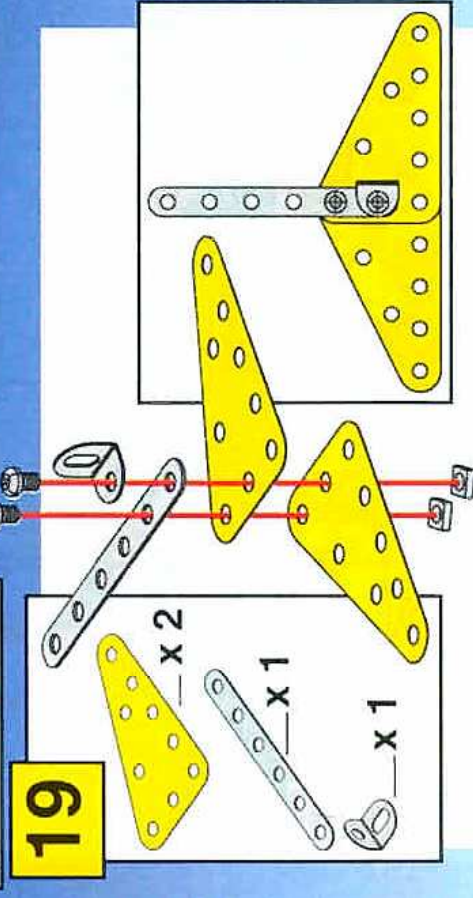
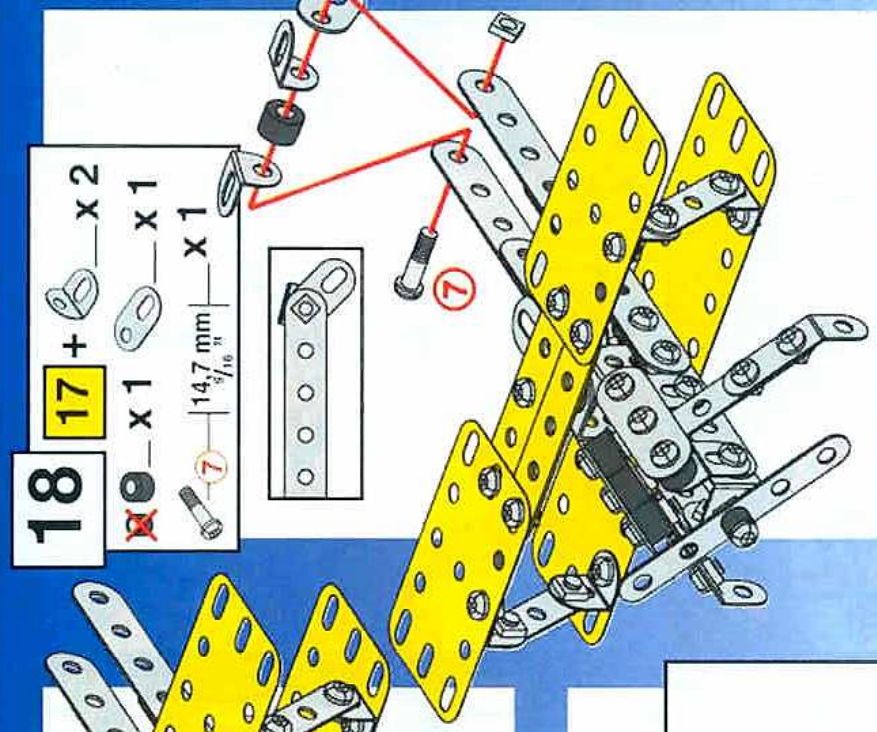

**19**

- x 2
- x 1
- x 1

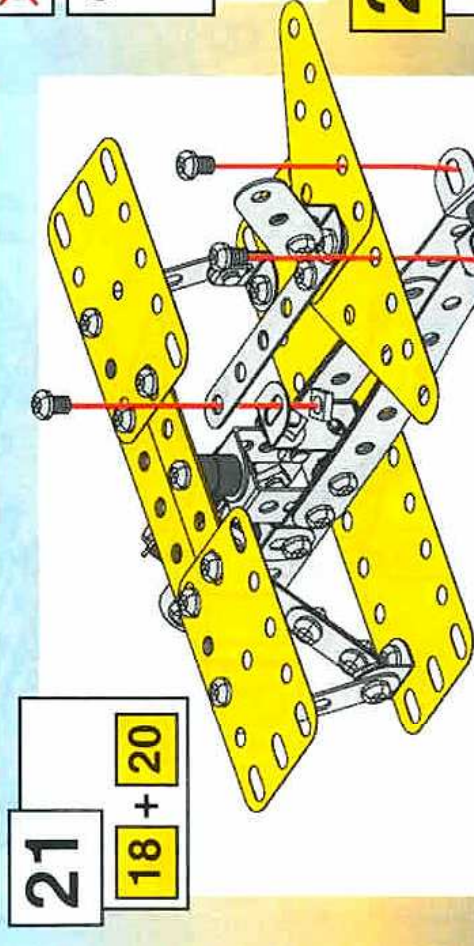

**21**

- 18** + **20**

**20**

- 19** + x 1
- x 1
- x 1

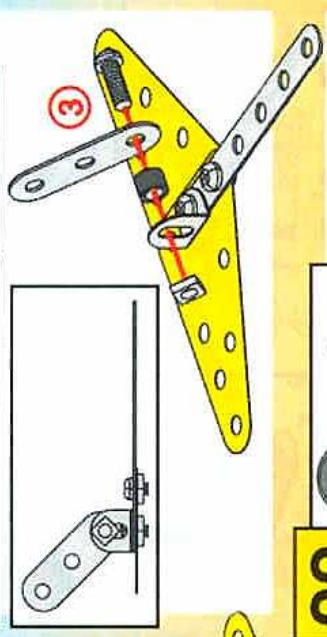

**22**

- x 2
- x 2
- x 2

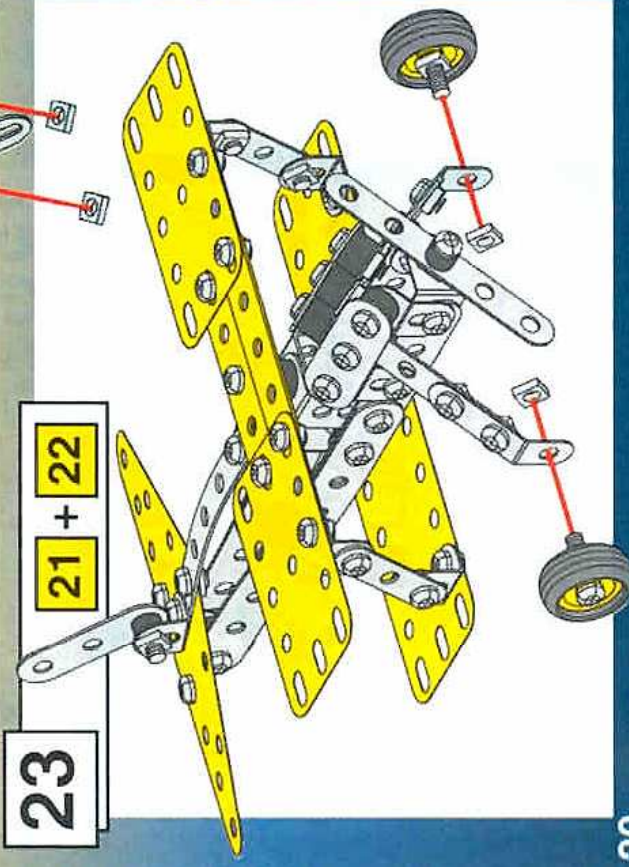
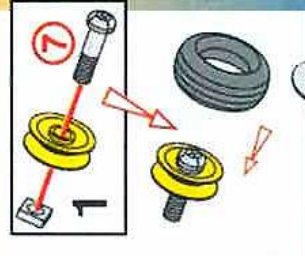

**23**

- 21** + **22**

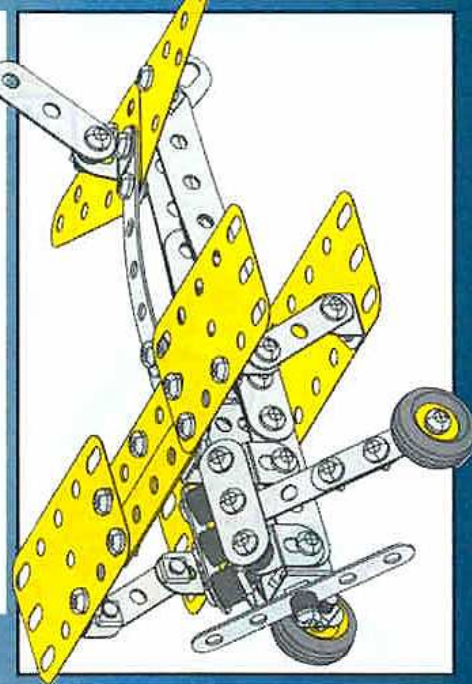

**1**

x1

x2

**2**

1+

x1

**3**

x1

x1

x1

12 mm 1/2

x1

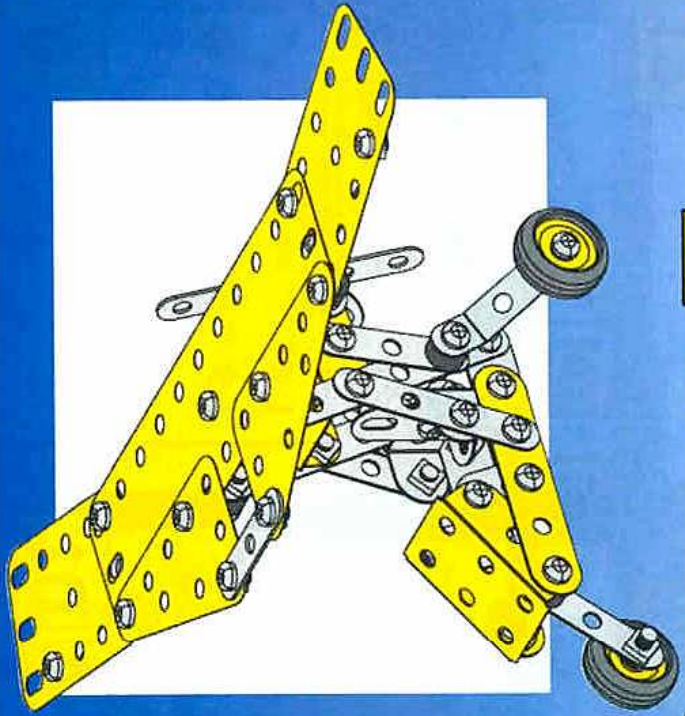

**4**

3+

x2

**5**

x1

x1

**6**

4+5+

x2

**7**

x1

x1

x1

12 mm 1/2

x1

**8**

7+

x1

x1

x1

12 mm 1/2

x1

**1**

**2**

**1**

**3**

**1**

**3**



**15** **14+**  
-x 2

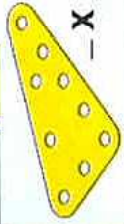
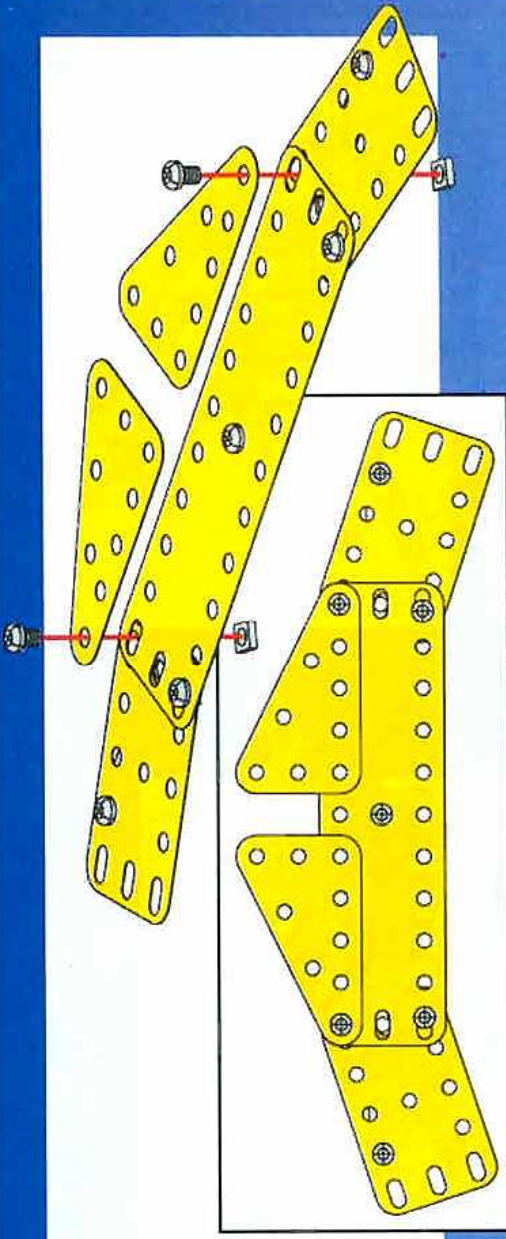

**16** ~~12~~-x 1



**17** **12+16**

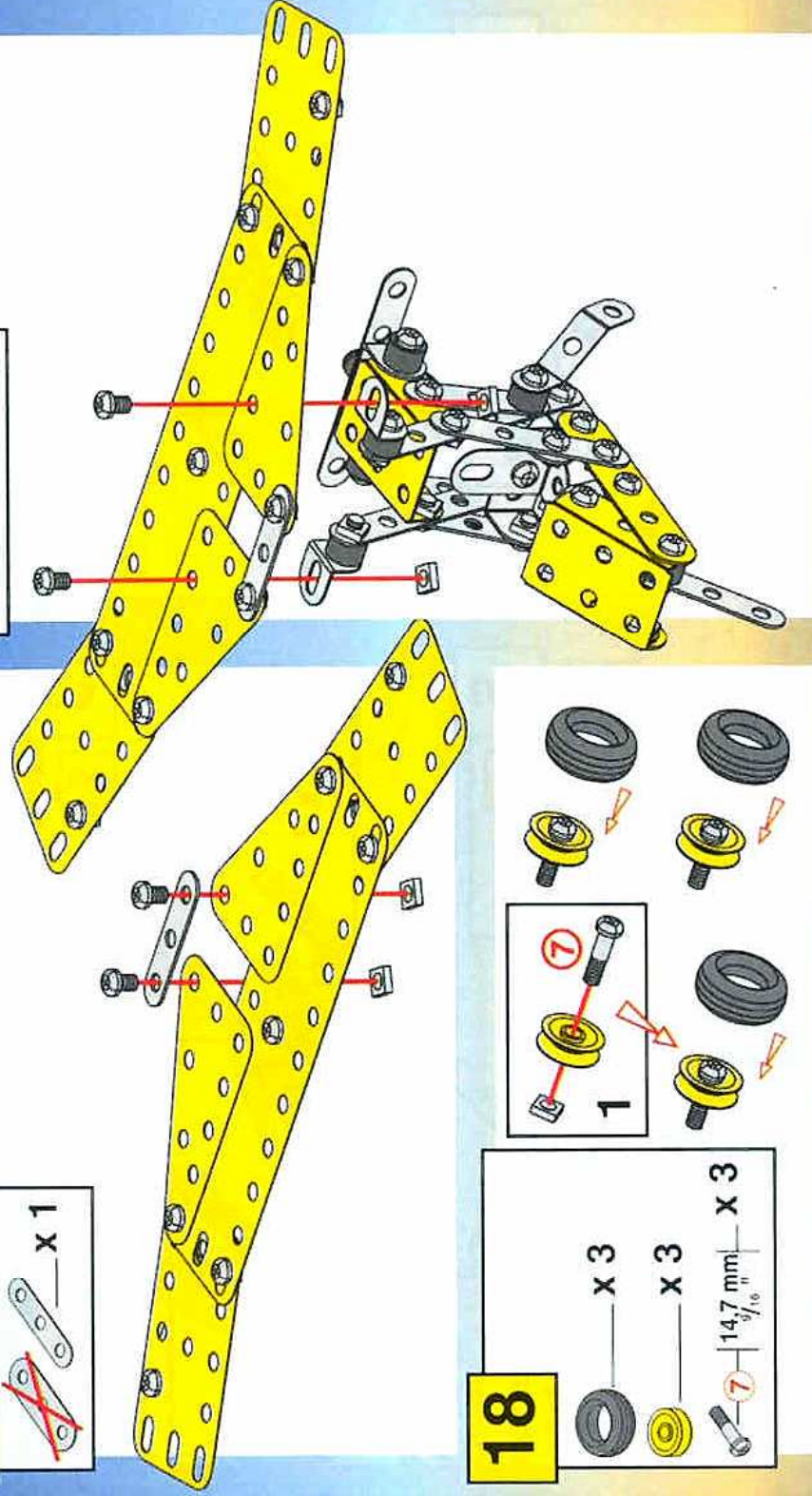

**18**

-  x 3
-  x 3
-  14,7 mm  $\frac{9}{16}$ " x 3

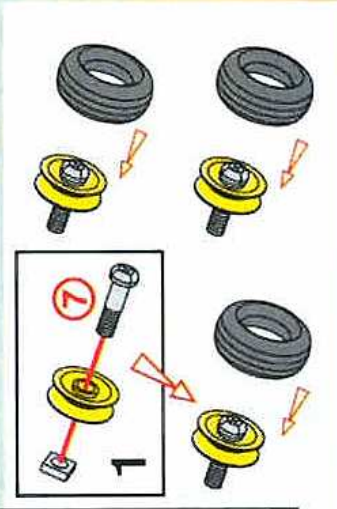

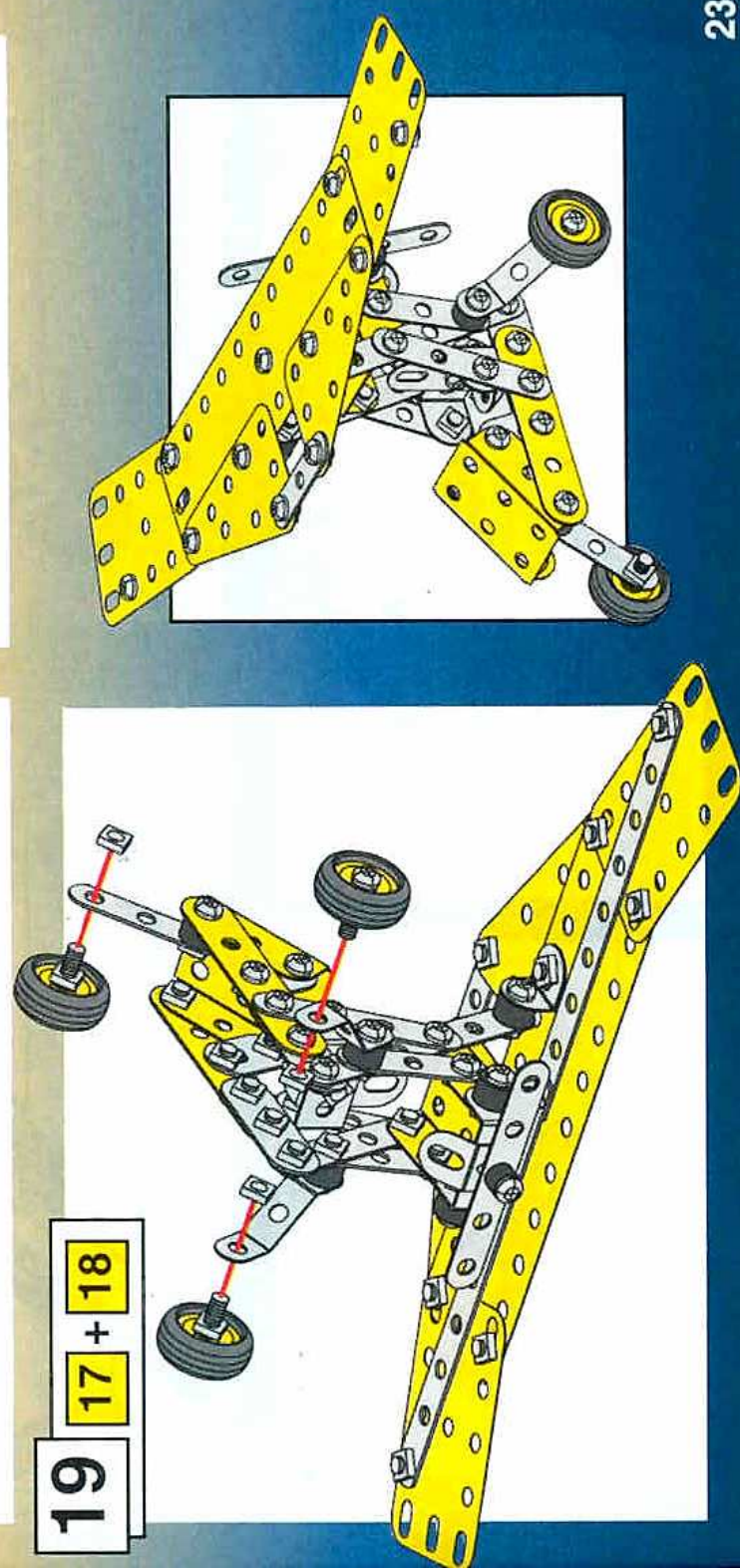

**19** **17+18**





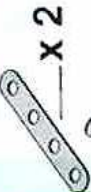

8

- 5 + 7 +
-  x 2
-  x 1

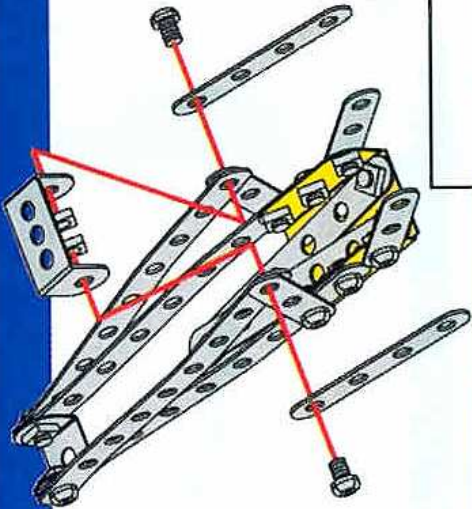



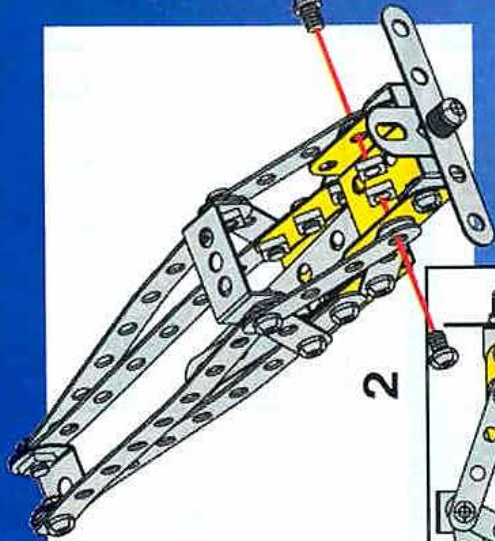



1

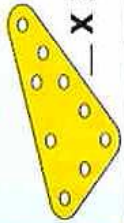

2



9

- ~~~~ x 1
-  x 1
-  x 2
-  x 1

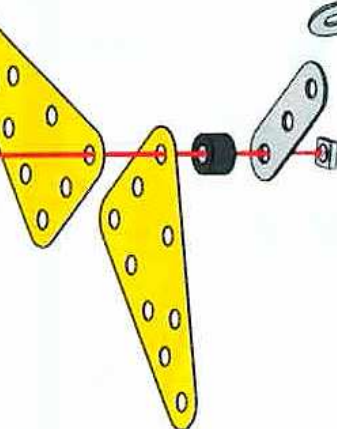
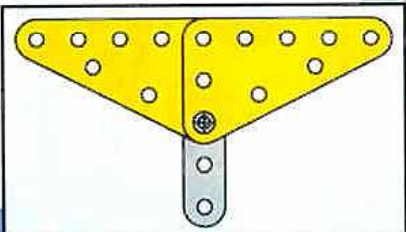
-  x 1
-  x 1





10

- 8 + 9 +
-  x 1
-  x 1
-  x 1

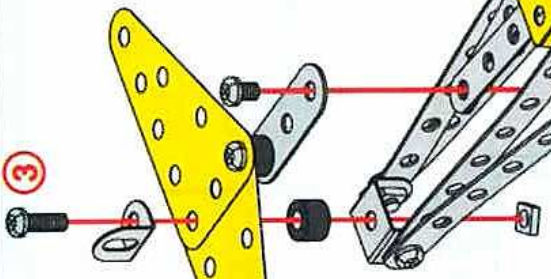
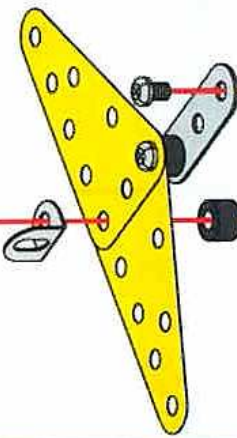
3



11

- 10 + ~~~~ x 1
-  x 1
-  x 1

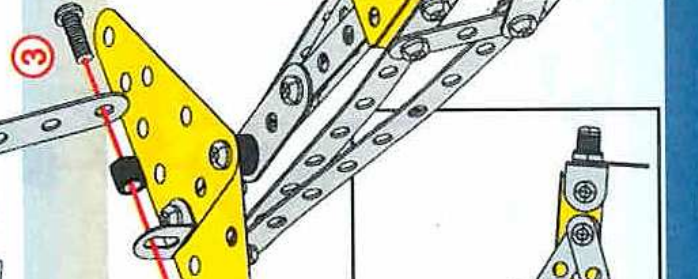
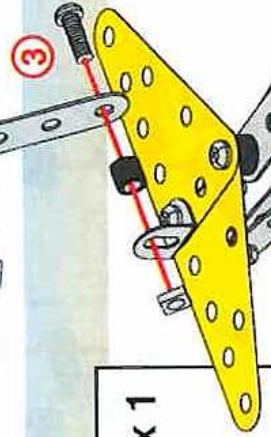

12

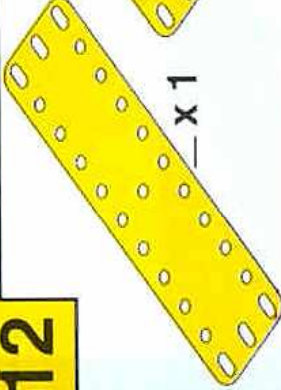
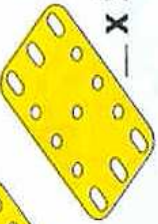
-  x 1
-  x 2

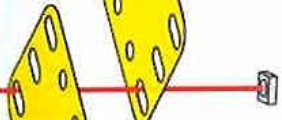
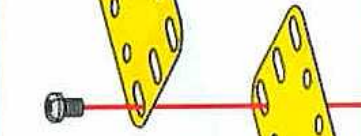

13

12+

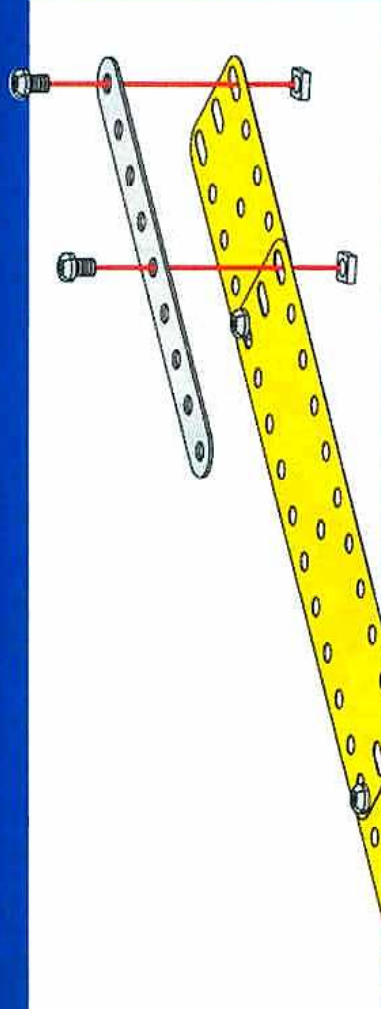
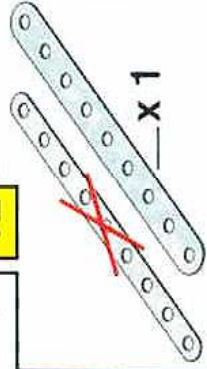

14

13+

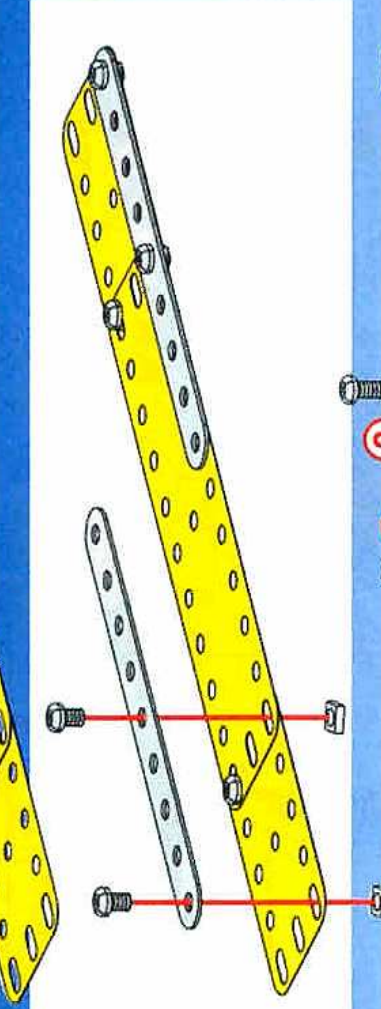
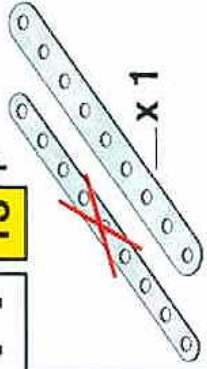

15

14+

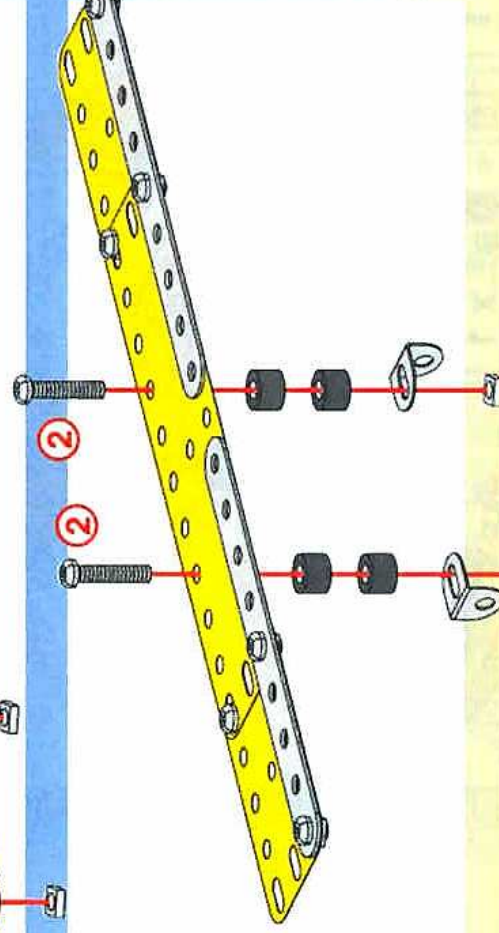
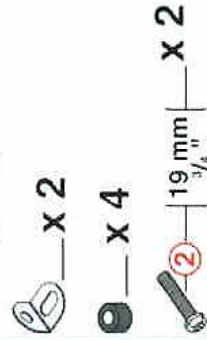

16

15+

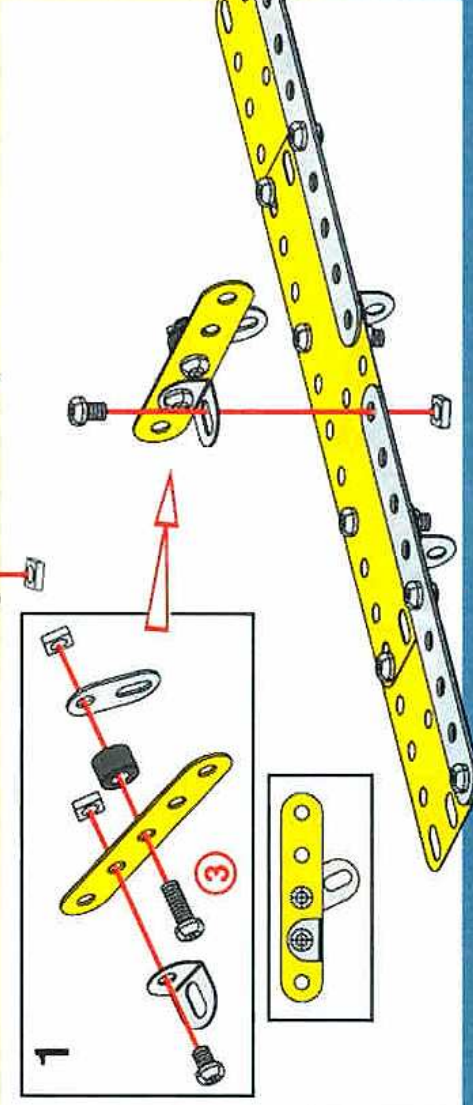
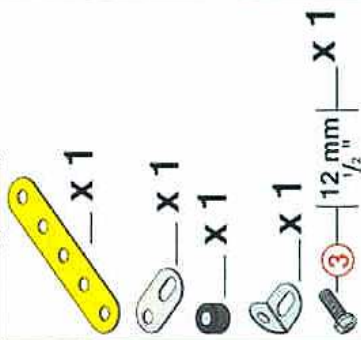

17

16+

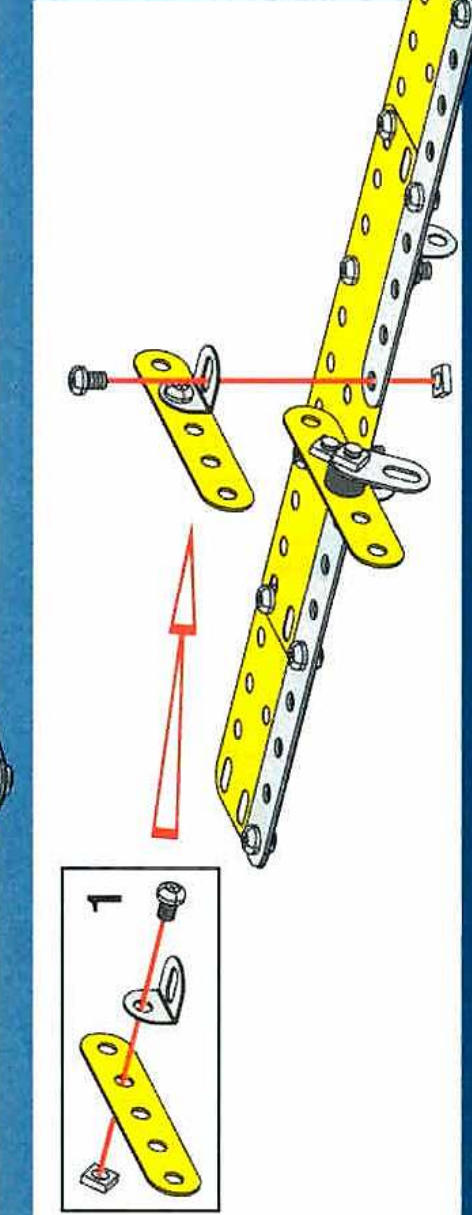
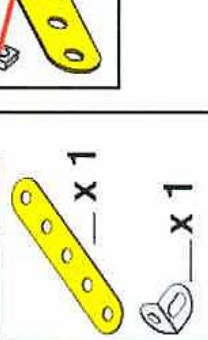

18 11 + — x 1

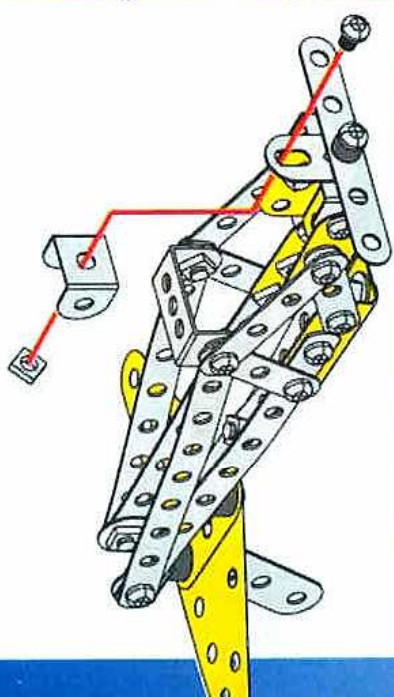

19 17 + 18

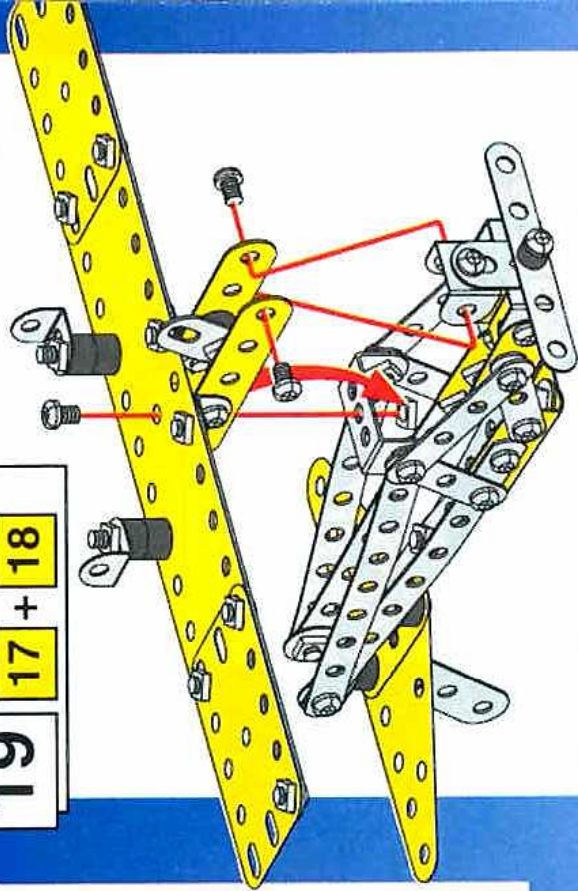

20 — x 3  
— x 3 | 14,7 mm | x 3

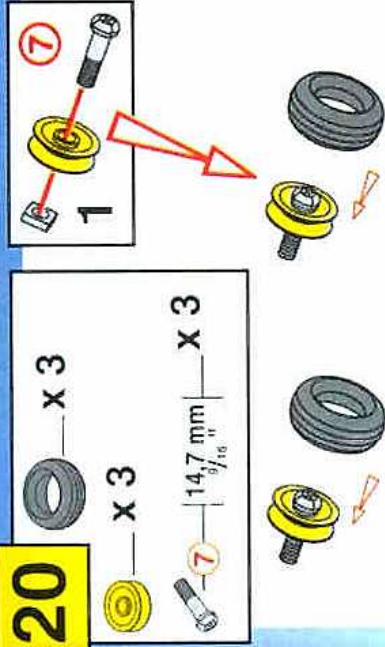

21 20 + — x 1

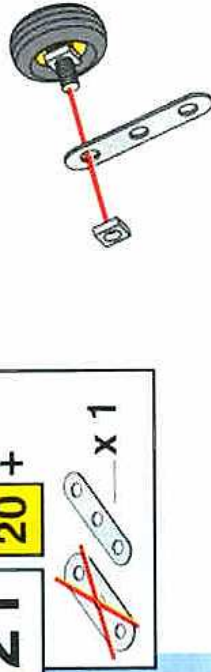

22 20 + 21 + — x 1  
— 12 mm | x 1

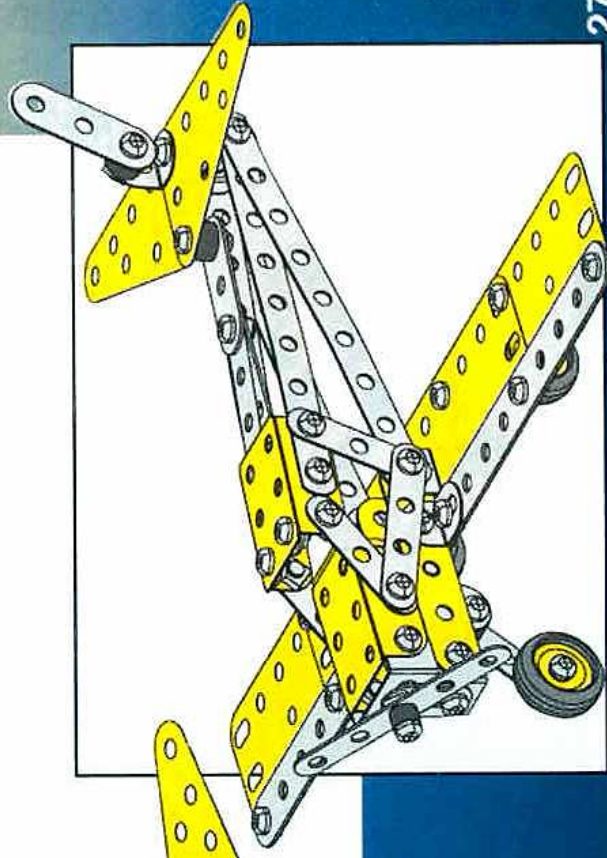
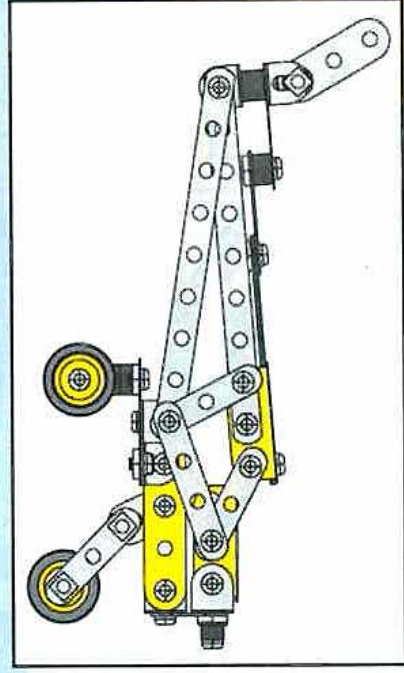
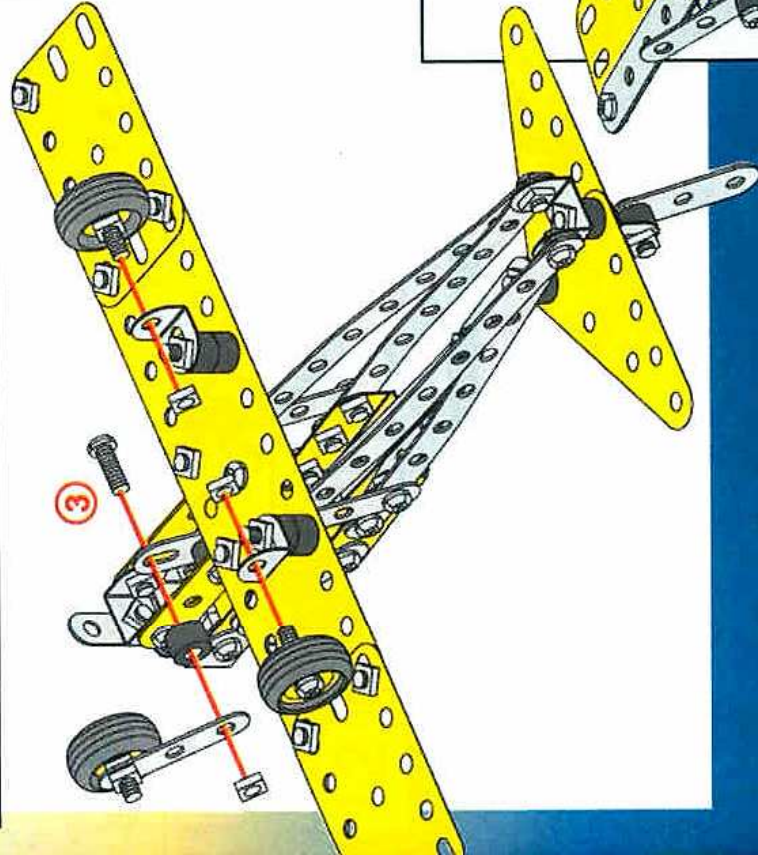

1

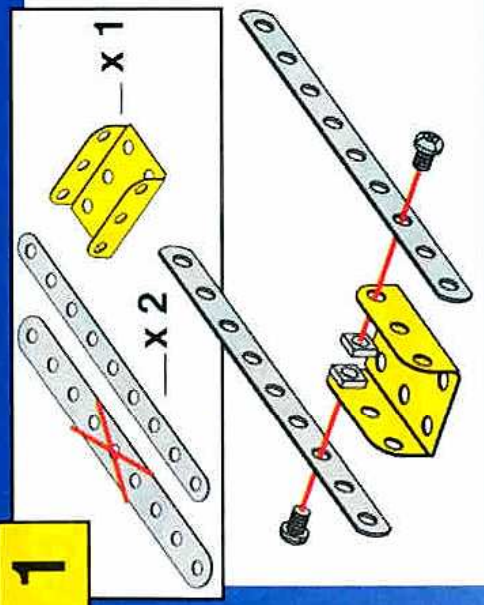

2

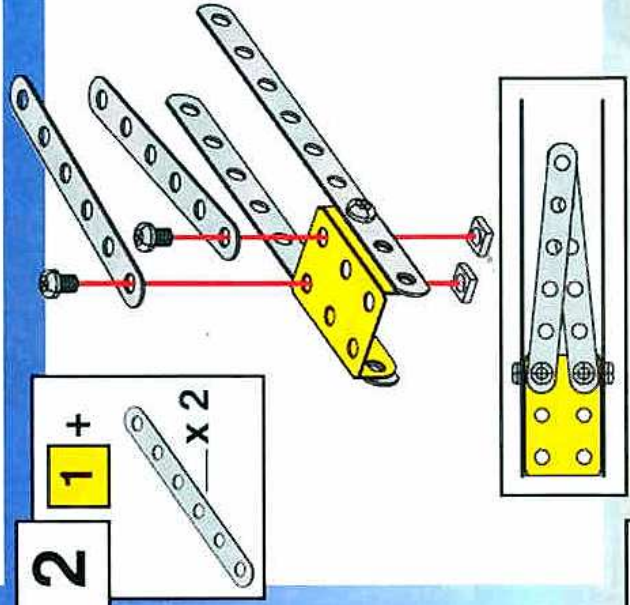

3

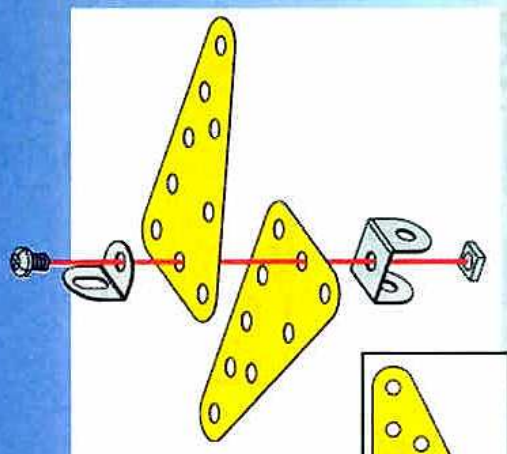
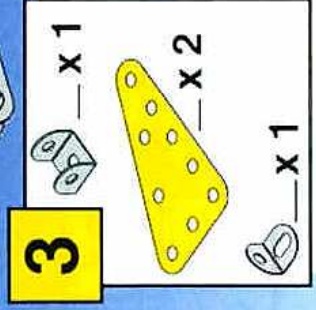

4

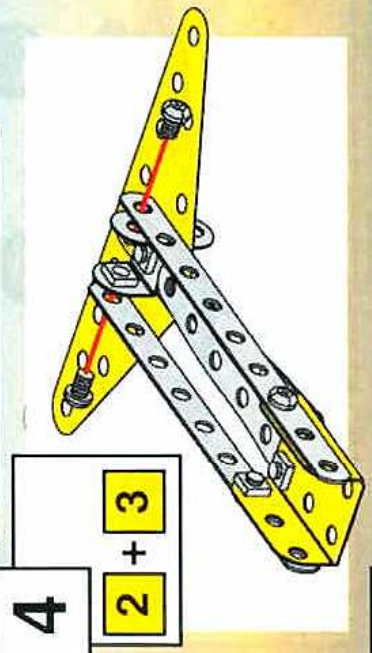

5

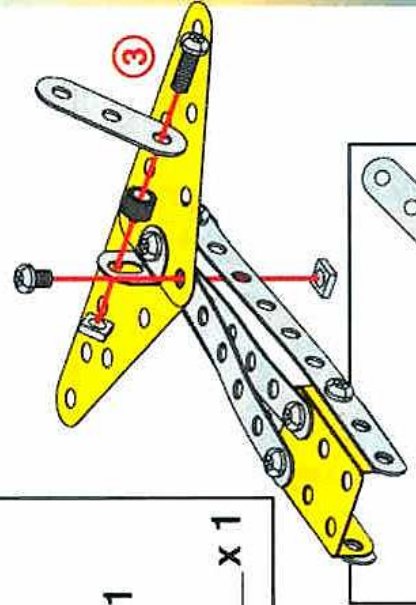
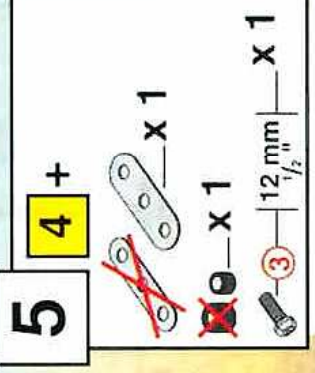

6

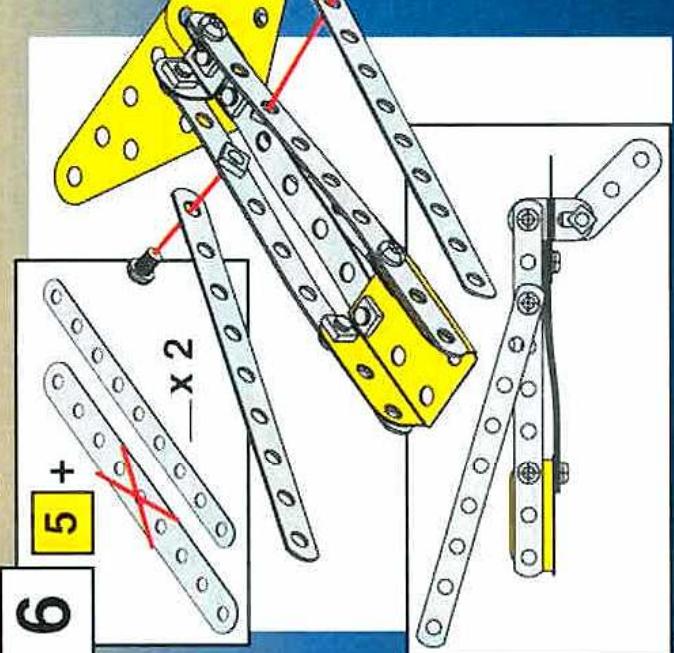

7

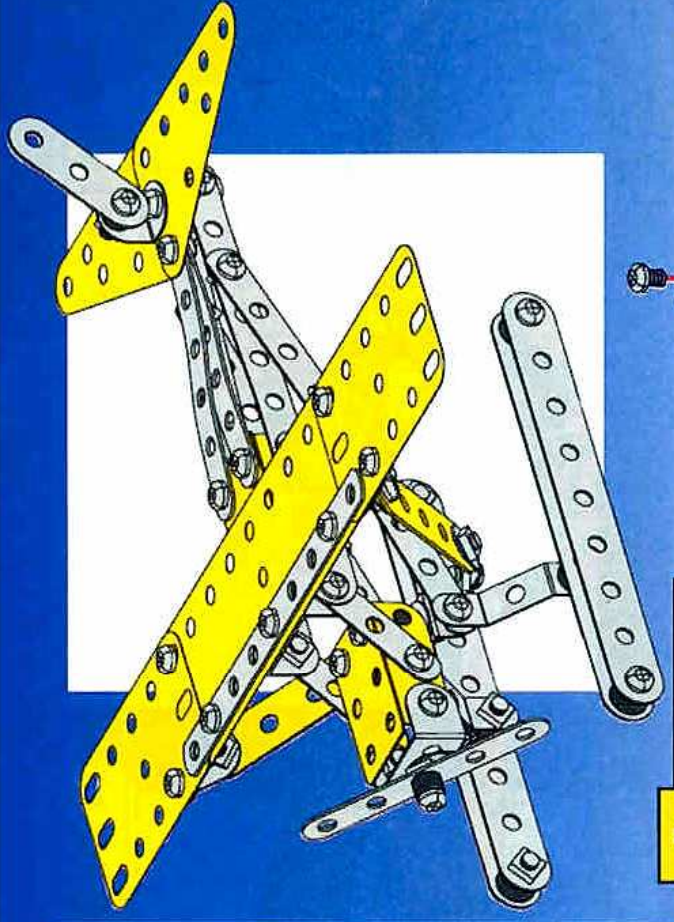
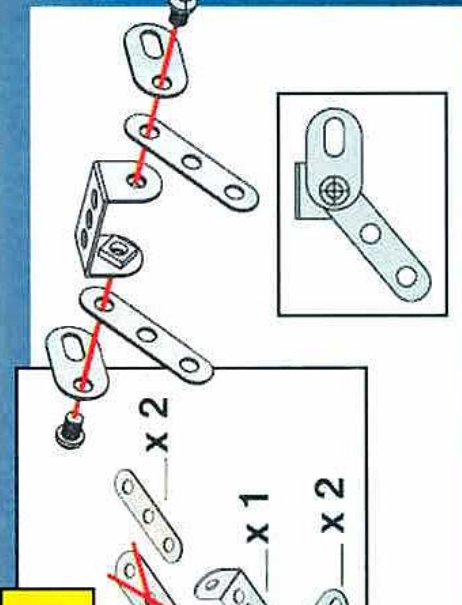
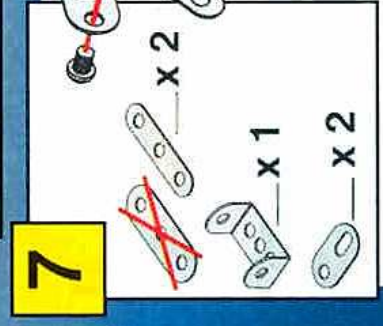

**8** **6** + **7** +  
-x2

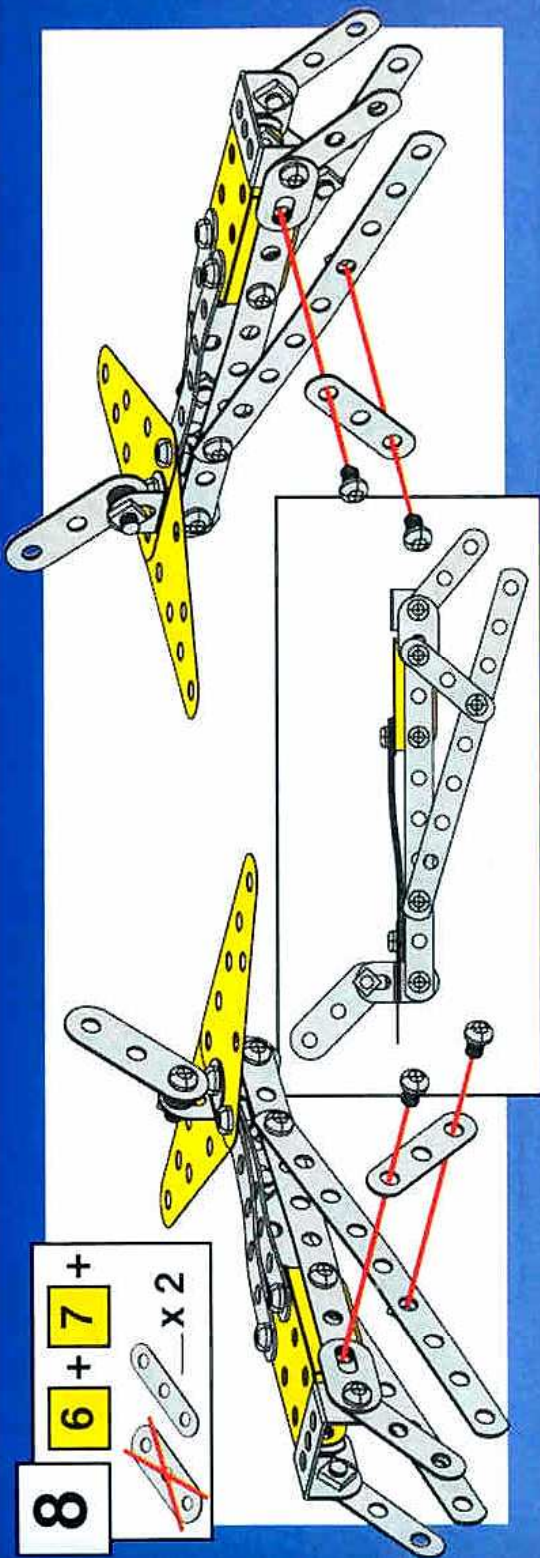

**9**

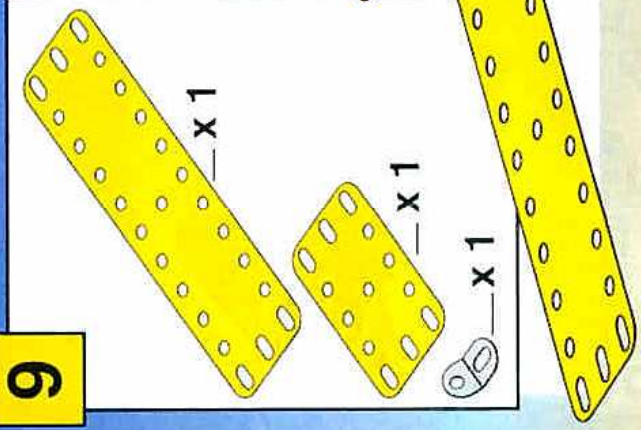

**10** **9** +

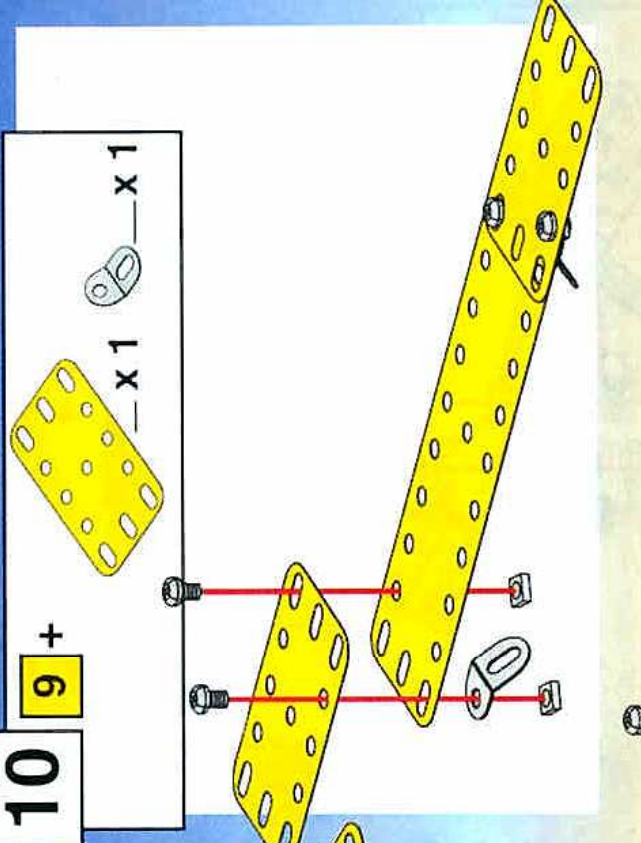

**11** **10** +

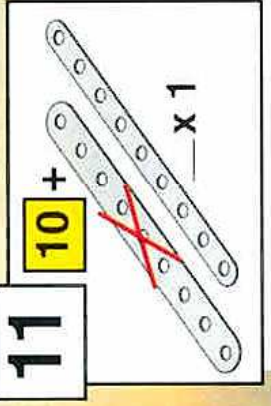

**12** **8** + **11**

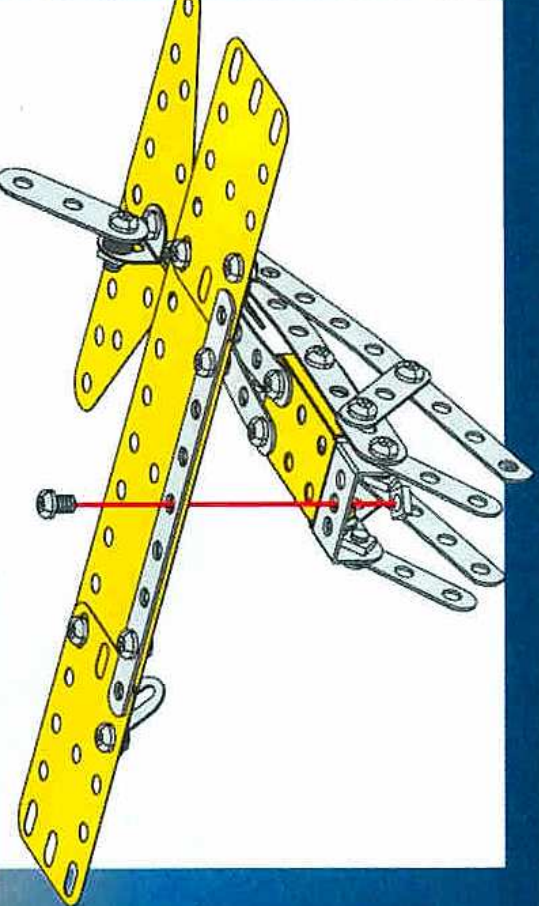

**13**

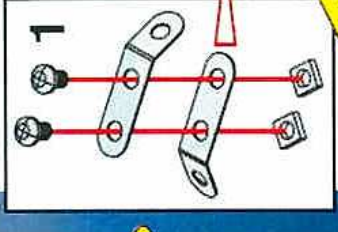
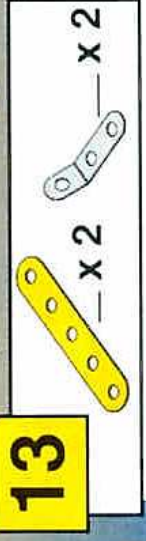

**2**

14 12 + 13

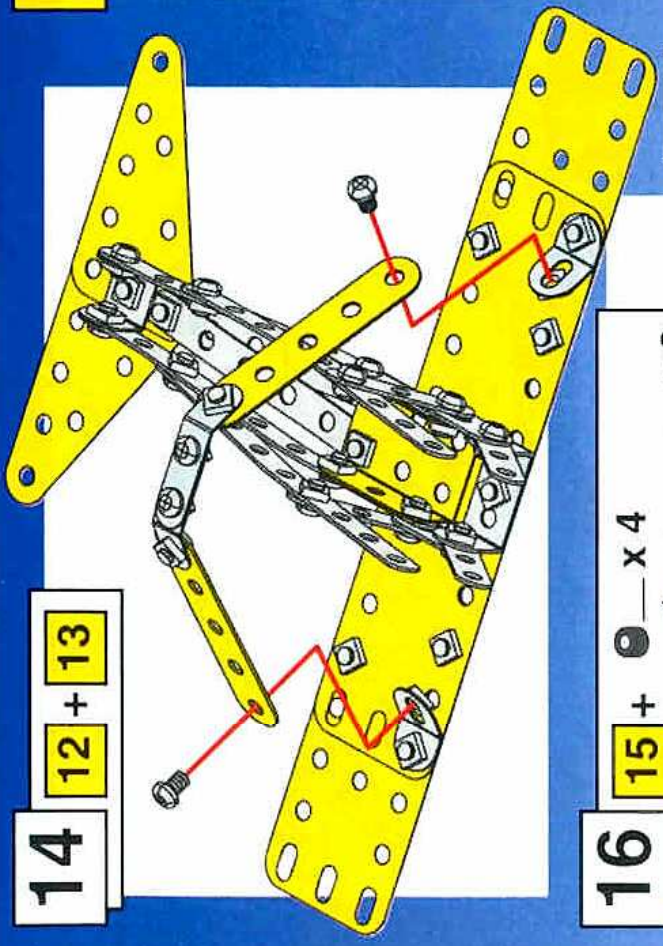

15

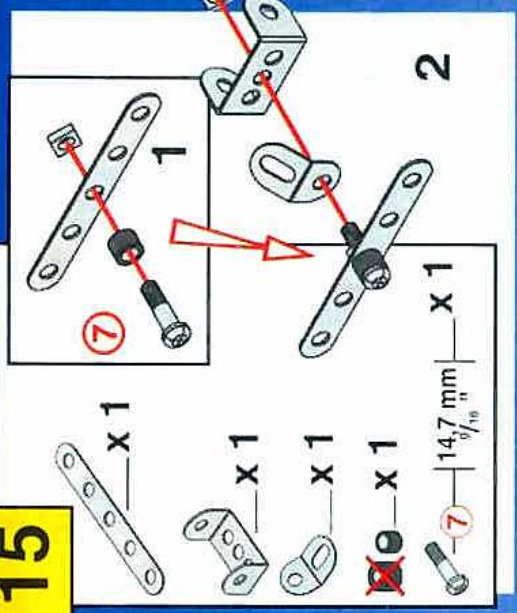

16 15 +

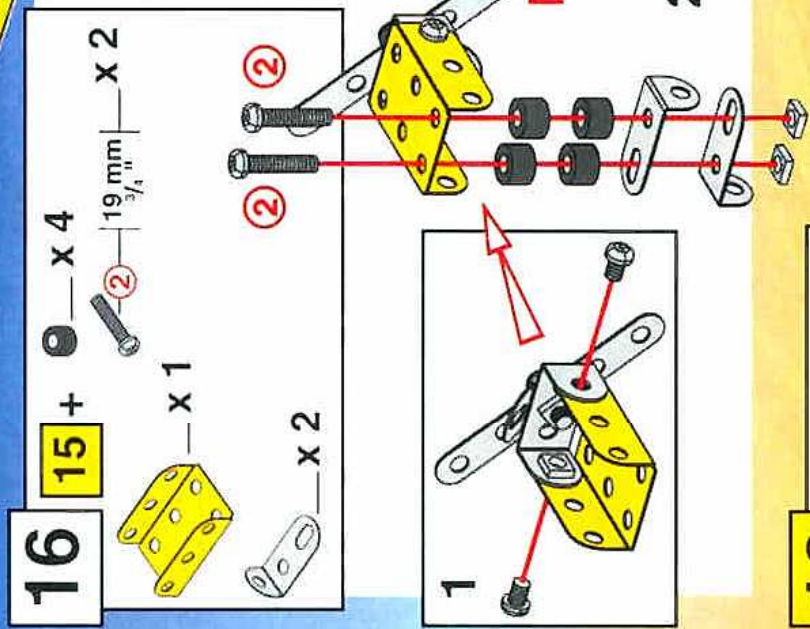

17 14 + 16

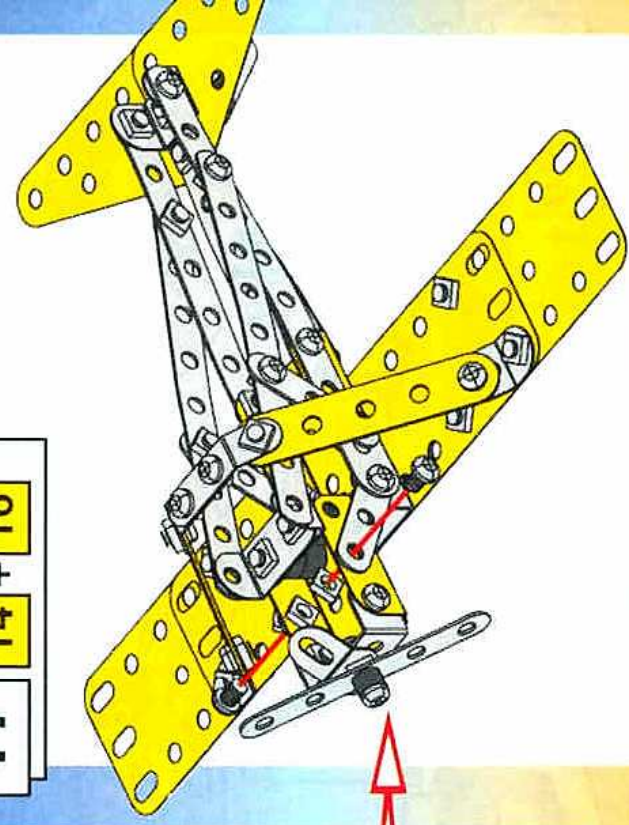

18



19 18 +

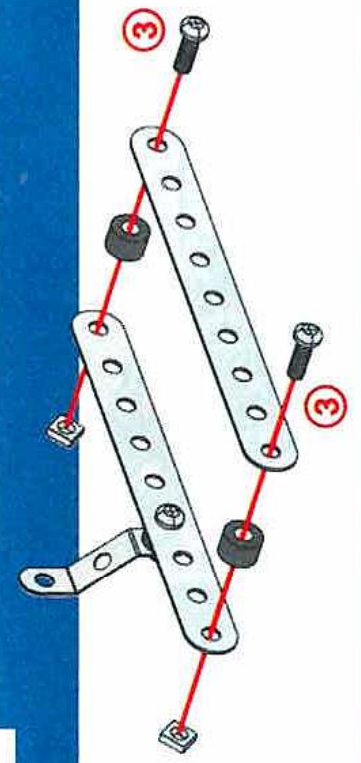
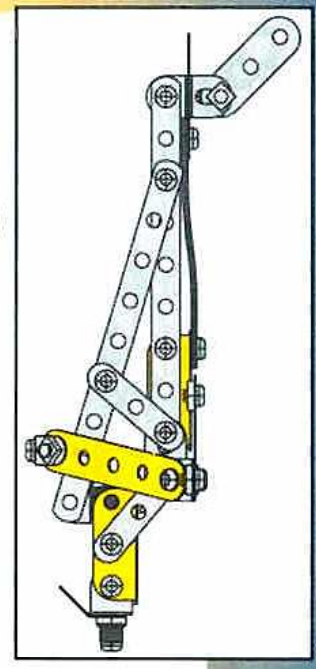
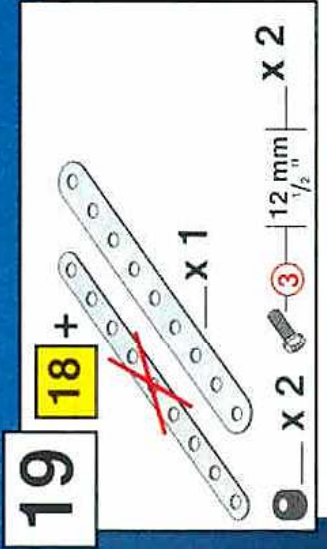

20 17 + 19

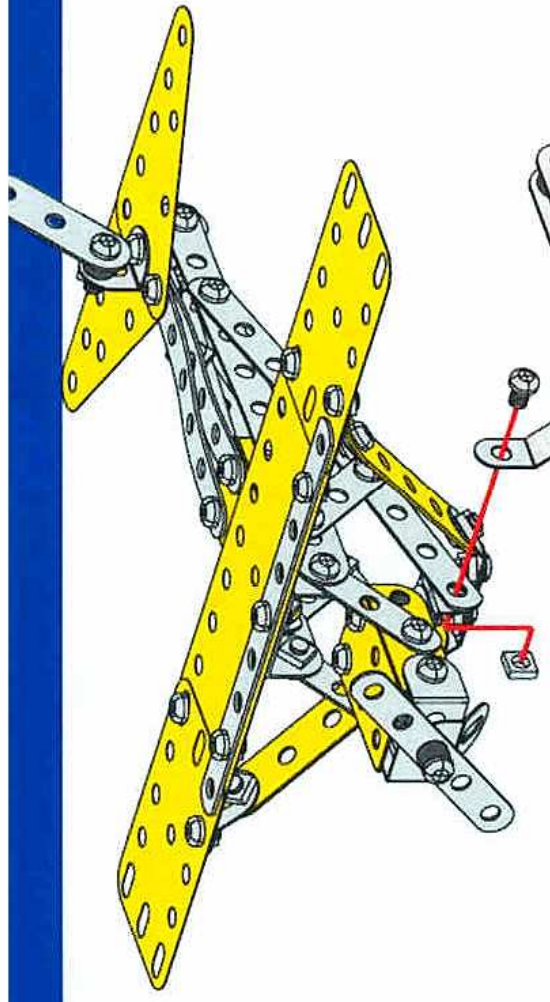

21

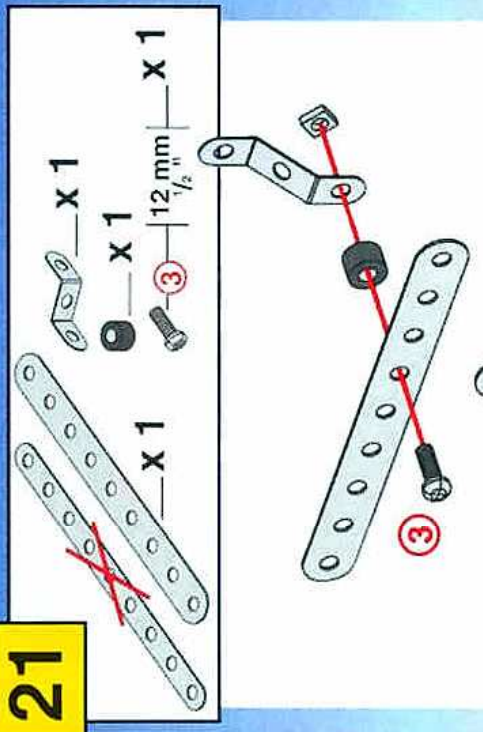

22

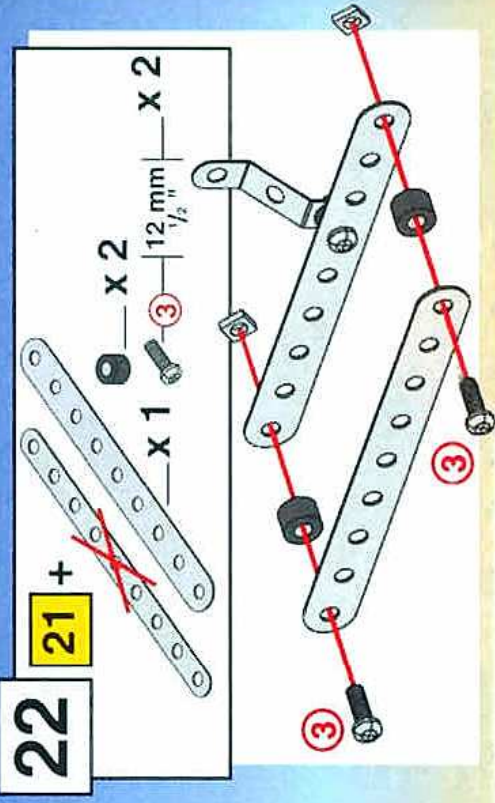

23

20 + 22

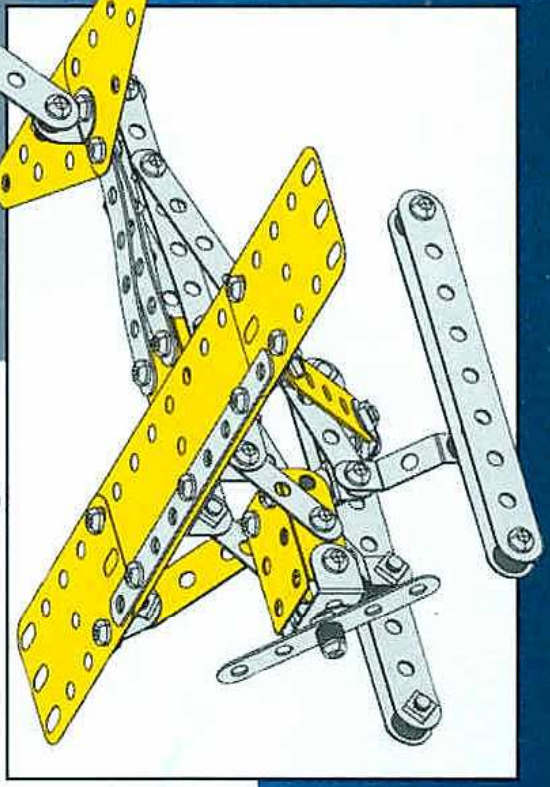
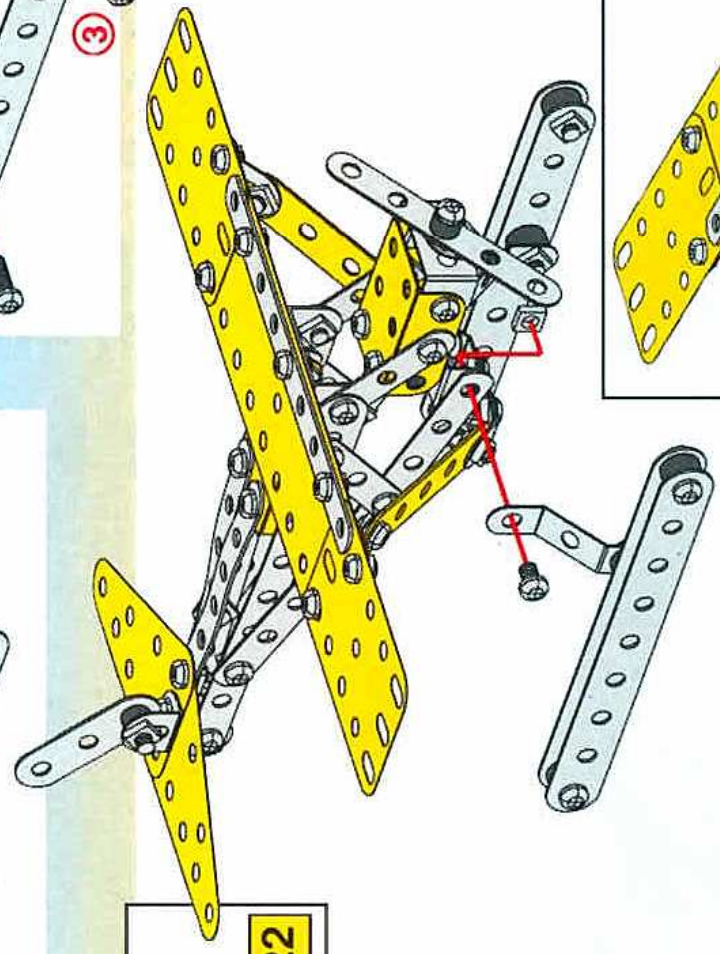

**GB** GLOSSARY  
**F** LEXIQUE  
**D** TEILE-LISTE  
**I** LESSICO  
**S** DETALJBESKRIVNING  
**SF** SANAKIRJA  
**DK** ORDLISTE  
**E** NOMENCLATURAS  
**NL** ONDERDELENLIJST  
**P** GLOSSARIO  
**GR** ΓΛΩΣΣΑΠΙ  
**JPN** 用語集



Perforated strip ± 9 holes  
 Bande ± 9 trous  
 Lochband  
 Banda ± 9 buchi  
 Lingbalk ± 9 hals  
 Reijlicterij lista

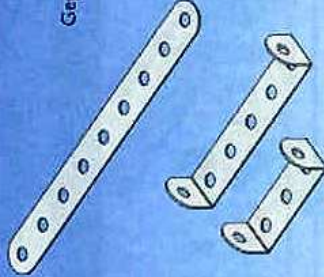

Element ± 9 huller  
 Vanilla ± 9 agujeros  
 Geperforeerde strook ± 9 gaten  
 Peça perfurada ± 9 furos  
 Διατρητό ποικλοστόρονο  
 στοιχείο ± 9 τρύπες  
 穴あき (±) プレート

Double angle strips  
 Bandes coudées  
 Winkel-Lochband  
 Banda a gomito  
 Dubbel vinklad balk  
 Kaksoiskulma lista

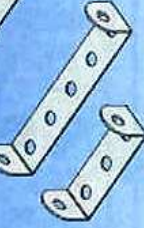

Angle girders ± 4 holes  
 Cornière ± 4 trous  
 Winkelreizen  
 Profiilato a L ± 4 fori  
 Vinkelbalk ± 4 hals  
 Kulmarauta



Flat plates  
 Plaques rigides  
 Feste Platten  
 Plastre rigide  
 Hälplatta, plät  
 Jäykkä levyjä

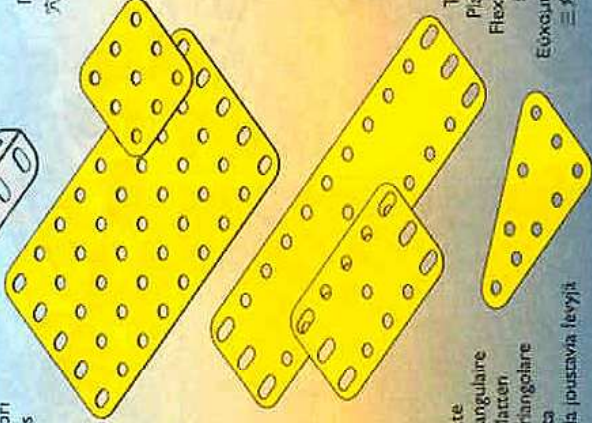

Faste plader  
 Placas rígidas  
 Vlakke platen  
 Placas rígidas  
 Ακαυτήτες πλάκες  
 プレート (硬い)

Flexible plates  
 Plaques flexibles  
 Flexibele Platten  
 Placera flessibili  
 Boijlig platta  
 Jouszavia levyjä

Bojelige plader  
 Placas flexibles  
 Flexibele platen  
 Placas flexíveis  
 Ευκαυτήτες πλάκες  
 プレート (柔らかい)

Triang. flexible plate  
 Plaque flexible triangulaire  
 Flexibele driehoek-Platten  
 Placera flessibile triangolare  
 Boijlig triangelpatta  
 Kolmion muotoisia jouszavia levyjä



Triokantet, bejeligt plade  
 Placa flexible y triangular  
 Flexibele driehoekige plaat  
 Placa flexível triangular  
 Ευκαυτήρι τρίγωνοει πλάκα  
 三角プレート (柔らかい)

Flanged sector plate  
 Plaque à rebords  
 Winkelplatten  
 Placera con bordi  
 Vinkelplatta  
 Kulmar levy



Kantplade  
 Placa con rebordes  
 Flensplaat  
 Placa con rebordes  
 Πλάκα με αντημιώληφα άκρα  
 縁付きプレート

Flange plate  
 Support plat  
 Flanchplattre  
 Supporto piatto  
 Stödjarn  
 Linnas tukkasa

Flanchplattre  
 Supporto lano  
 Streutzuk  
 Supporto piano  
 Επιστέδο τραπέζοει οπτητόπτε  
 サポート板

Angle brackets 90° (135°)  
 Esquinas 90° (135°)  
 90° (135°) Winkelbuisen  
 Squadra 90° (135°)  
 Μεταεπίρ, 90°  
 Kulmarvauraus 90° (135°)



Vinkelbeslag på 90 grader (135 grader)  
 Angulas 90° (135°)  
 Hoekstukken 90° (135°)  
 Angulos 90° (135°)  
 Tamsus 90° (135°)  
 コーナ・ブレイク 90度 (135度)

Double brackets  
 Supporto doppie  
 Doppelpatrize  
 Supporto doppi  
 Laperitoed, dubbelt  
 Kaksoistuet



Reversed angle bracket  
 Equerre renversée  
 Doppelwinkel  
 Squadra capovolta  
 Dubbelwinkel  
 Kaksoiskulma



Corner bracket  
 Petit gousset d'assemblage  
 Kleiner eckwinkel  
 Piccolo raccordo d'assemblaggio  
 Hörhörzankring  
 Kulmatuki



Axle rod  
 Tringile  
 Stange  
 Barra  
 Axel  
 Aksellitanko



Pulleys  
 Poulies  
 Rollen  
 Pulegge  
 Remskiva  
 Hihnapyörri



Remskive  
 Poleas  
 Riemschijven  
 Roldenas  
 Τροχαλία  
 車輪

Set collar  
 Bague d'arrêt  
 Haltering  
 Anello di sicurezza  
 I stoppring  
 Turvaprikka



Stopping  
 Anilla de parada  
 Kraag met stelschroef  
 Anilha de travamento  
 Περιστοιχιο  
 止めリング

Washers  
 Rondelles  
 Lochscheiben  
 Rondelle  
 Bricker  
 Prikkoja



Flade ringe  
 Arandelas  
 Onderlegningen  
 Anilhas  
 Podšlacs  
 座金

Spacer  
 Entretoise  
 Steg  
 Briglia di collegamento  
 Distanshylsa  
 Välholkki  
 Ierrepultti



Mellemsykkje  
 Codal  
 Dwaarsstukken  
 Españador  
 Ευρυχόςος  
 セパレータ

Stud bolt  
 Boulon pivot  
 Zapfenschraube  
 Bullone-permo  
 Stödbult  
 Nuppillinen kierrepultti



Tapskrue  
 Pivote  
 Bout met kop  
 Parafuso pivot  
 Μτσουκί  
 ヒボット・ボルト

Grub screw  
 Vis (sans tête)  
 Flachschraube  
 Vite (senza testa)  
 Skruv  
 Ruuvi (ilman nuppia)



Schruve (hovedløs)  
 Tornillo (sin cabeza)  
 Verzonken schroef  
 Parafuso sem cabeça  
 Βίδα χωρίς κεφαλή  
 無頭ねじ

Square nut  
 Ecrou carré  
 Vierkantmutter  
 Diado quadrado  
 Fyrkantmutter  
 Mutter



Firkantet mørtik  
 Tuercu cuadrada  
 Vierkante moer  
 Poza quadrada  
 Τετραγωνικό μοιζιότι  
 四角ナット

Open ended spanner  
 Clé pour écrou  
 Schlüsselwrench  
 Chiave per dadi  
 Μύρσημυρική  
 Kinnstävspann



Motorknyggle  
 Llave para tuercas  
 Schlüssel-wrench  
 Chave de porcas  
 ΚΑΛΩΝ ΠΙΑ ΤΡΑΠΕΖΙΩΝ  
 車輪ナット

Allen keys  
 Clé 6 pans  
 Sechskantenschlüssel  
 Chiave per dadi esagonali  
 Sechskantenschlüssel  
 Kuntavaimin



Saksavaimin  
 Llave para tornillos de 6 caras  
 Inbenschlüssel  
 Chiave hexagonale  
 Sechskantenschlüssel  
 Kuntavaimin  
 六角ナット